

# ZEE LINE

**FLUID MANAGEMENT EQUIPMENT**  
*Trusted Lubrication Solutions Since 1947*

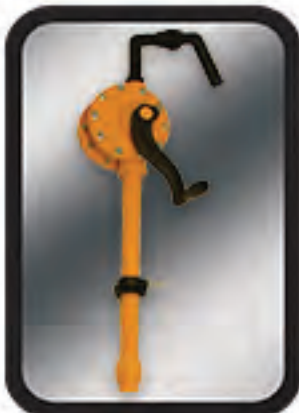

**OIL**

**GREASE**

**FUEL**

**DEF**

**CHEMICAL**

**ACCS**



**Product Catalog 2021/2022**

*National - Spencer, Inc.*

## Top Fourteen *Best Sellers*



### 912-19L

- 19.2V Battery Operated Grease Gun
- Pg. 50



### 321

- Gear Lube Hand Pump
- Pg. 29



### 375

- Chemical/DEF Lever Pump
- Pg. 80



### 1040

- 1" Double Diaphragm Pump
- Pg. 16



### 1504

- Non-Preset Digital Meter
- Pg. 22



### D-S

- Oil Lever Pump for 15-55 gallon drums
- Pg. 30



### 1712

- 3:1 Air Ratio Oil Pump
- Pg. 10



### 3574R

- 50:1 Air Ratio Greasing System for 5 gallon pails
- Pg. 40



### 1444R

- 49' Heavy-Duty Oil Reel
- Pg. 86



### 10211

- Chemical/DEF Rotary Pump for 15-55 gallon drums
- Pg. 74



### 227

- Low Profile Truck Drain
- Pg. 35



### HD4A

- Premium Lever Grease Gun
- Pg. 55



### 7019

- Battery Operated Chemical/DEF Pump
- Pg. 70



### 7050

- AC 110 Volt Electric Oil Pump
- Pg. 4



Look for the "Best Seller" stamp to identify Best Selling items.

# Table of Contents

<b>Top 14 Best Sellers . . . . .</b>	<b>Inside Cover</b>	<b>Specialty Pumps . . . . .</b>	<b>82</b>
<b>Table of Contents . . . . .</b>	<b>3</b>	<b>Value Pumps . . . . .</b>	<b>83</b>
<b>Oil Equipment . . . . .</b>	<b>4-39</b>	<b>Accessories . . . . .</b>	<b>84-101</b>
Oil Equipment Packages . . . . .	5-7	Tank Accessories . . . . .	84
Air Operated Oil Pumps . . . . .	10-19	Hose Assemblies . . . . .	85
Oil Dispensing Stations . . . . .	13	Hose Reels . . . . .	86-87
Metered Control Handles . . . . .	20-25	Drum Equipment . . . . .	88-92
Non-Metered Control Handles . . . . .	26	Air Sentry Breathers . . . . .	93
Tote Mounted Equipment . . . . .	27	Funnels . . . . .	94-95
Electric Oil Pump . . . . .	28	Measures & Containers . . . . .	96
Hand Pumps . . . . .	29-34	Electrical Reels . . . . .	97
Waste Oil Drains . . . . .	35-39	Air Controls . . . . .	98
		Tools . . . . .	99
		Industrial Cleaning Products . . . . .	100-101
<b>Grease Equipment . . . . .</b>	<b>40-61</b>	<b>Chemical Resistance Chart . . .</b>	<b>102-103</b>
Air Operated Grease Systems . . . . .	40-44	<b>Index by Part Number . . . . .</b>	<b>104-108</b>
Grease Handles . . . . .	45	<b>Notes . . . . .</b>	<b>109</b>
Follower Plates . . . . .	46	<b>Maximum Response Team . . . . .</b>	<b>110</b>
Hand Grease Pumps . . . . .	47	<b>New Products . . . . .</b>	<b>Inside Cover</b>
Bearing Packers . . . . .	48		
Grease Gun Filler Pumps . . . . .	49		
Grease Guns . . . . .	50-55		
Grease Gun Accessories . . . . .	56-57		
Grease Couplers . . . . .	59		
Grease Fittings . . . . .	60-61		
<b>Fuel Equipment . . . . .</b>	<b>62-69</b>		
Electric Fuel Pumps . . . . .	62-63		
Hand Fuel Pumps . . . . .	64-67		
Fuel Accessories . . . . .	68-69		
<b>DEF Equipment . . . . .</b>	<b>70-75</b>		
Battery Operated Pump . . . . .	70		
DEF Pumping Systems . . . . .	71-73		
Hand Pumps . . . . .	74		
Couplers & Accessories . . . . .	75		
<b>Chemical Equipment . . . . .</b>	<b>76-81</b>		
Specialty Pumps . . . . .	76		
Air Operated Pumps . . . . .	77		
Hand Pumps . . . . .	78-81		



Dimensions - Height: 108" x Width: 58" x Depth: 26"

### FCRS-100

- Complete Oil System
- Rack System can be attach to the wall, ceiling, or floor for proper support.

To purchase mounting rack separately, use part # (FCR-100R)

#### System Includes:

- (2) 1700R 3:1 Pumps
- (2) 1475R 32' Hose Reels
- (2) 1504 Digital Meters
- (1) 782 Two Drum Spill Containment Pallet
- (1) 783 Drum Loading Ramp
- All Connection Hoses and Hardware

Can be expanded to accommodate 4 drums using the same mounting rack.



783 - Drum Loading Ramp



Measure Not Included

### 7050

- AC 110 Volt electric oil pump.
- Flow Rate: 5 GPM
- Maximum Viscosity: 30wt
- Designed to fit 55 gallon drums up to 330 gallon totes.
- Spout and non-drip tip for filling measures and containers easily and without making a mess.
- Approximately 12" of clearance between the barrel and discharge spout.
- Includes 20 volt DC power supply with 6 amp output (7051)



(7051)



- 33.5" to 49"

12" -



Non-Drip Spout

# OIL EQUIPMENT PACKAGES



**BEST  
SELLER**  
(1712)



**1712**

**BEST  
SELLER**  
(1444R)



**1475R / 1444R**



**1520**

**BEST  
SELLER**  
(1504)



**1504**

**Basic Packages:** Pumps on Pg. 10, 15; Reels on Pg. 86; Meters on Pg. 21, 22, 24.

Package #	Pump	Reel / Hose	Meter / Handle
6104	3:1 Stub (1712)	25' Hose (2225)	Digital Quart (1504)
6105	3:1 Stub (1712)	49' Reel (1444R)	Digital Quart (1504)
6112	3:1 Stub (1712)	49' Reel (1444R)	Mechanical (1515)
6116	3:1 Stub (1712)	32' Reel (1475R)	Mechanical (1515)
6120	3:1 Stub (1712)	49' Reel (1444R)	Mechanical Preset (1520)
6124	3:1 Stub (1712)	32' Reel (1475R)	Digital Quart (1504)
6204	3:1 55 Gallon (1702R)	25' Hose (2225)	Digital Quart (1504)
6520	5:1 Stub (1730A)	49' Reel (1444R)	Mechanical Preset (1520)

**4-Wheel Cart Packages:** Include a 4-wheel cart (148 or 148G) Pg. 88.

Package #	Pump	Reel / Hose	Meter / Handle
6401	3:1 (1702R) fits 55 Gallon Drum	32' Reel (1475R)	Digital Quart (1504)
6403	3:1 (1714) fits 55 Gallon Drum	32' Reel (1475R)	Mechanical (1515)
6404	3:1 (1702R) fits 55 Gallon Drum	32' Reel (1475R)	Mechanical (1515)
6405	5:1 (1745) fits 55 Gallon Drum	32' Reel (1475R)	Digital Quart (1504)



**6403**

See Pgs. 6 & 7 for additional packages.

**Tote Mounting Packages:** Include a Tote Bracket (6601), and Suction Tube (15216).

Package #	Pump	Reel / Hose	Meter / Handle
6611	3:1 Stub (1712)	32' Reel (1475R)	Mechanical (1525G)
6612	3:1 Stub (1712)	32' Reel (1475R)	Mechanical (1515)
6613	3:1 Stub (1712)	25' Hose (2225)	Digital Quart (1504)
6614	3:1 Stub (1712)	32' Reel (1475R)	Digital Quart (1504)



**6611**



**1559A-ASSY**

**ALL Equipment packages include (1559A-ASSY), which consists of a night time drain, regulator, gauge, ball valve, and the male and female quick disconnect couplers. Packages also include other connecting components.**

## Reel

**NEW**

## Packages include:

- Cart with locking casters
- ½" x 32' Hose Reel (**1475R**)
- Available with 148 or 148G cart

**Optional:**

- DG-55 Drum Gauge
- 169 Non Sparking Drum Wrench



Kit #6416 pictured  
Shown with 148 cart

Kit	Meter	Pump	Pump Ratio
6416	1520	1702R	3:1
6418	1522	1702R	3:1
6417	1515	1702R	3:1
6408	1504	1702R	3:1
6807	1520	1712	3:1
6808	1522	1712	3:1
6806	1515	1712	3:1
6805	1504	1712	3:1
6422	1520	1745	5:1
6421	1522	1745	5:1
6419	1515	1745	5:1
6412	1504	1745	5:1
6811	1520	1730A	5:1
6812	1522	1730A	5:1
6810	1515	1730A	5:1
6809	1504	1730A	5:1
6411	1520	1730RP	5:1
6409	1504	1730RP	5:1
6501	1535	1730RP	5:1
6410	1515	1730RP	5:1



- 5 year Diamond Select Warranty on pumps 1702R, 1712, 1745, 1730A
- 2 year limited warranty on reel, meter and cart
- 1 year limited warranty on pump 1730RP

Pumps on Pg. 10, 15; Reels on Pg. 86; Meters on Pg. 20, 21, 22, 24; Carts on Pg. 88

 Pumps: 1702R / 1745

 Pumps: 1712 / 1730A

 Pump: 1730RP

# OIL EQUIPMENT PACKAGES



No Reel



## Packages include:

- Cart with locking casters
- ½" x 15' Rubber Hose (2215)
- Available with 148 or 148G cart



### Optional:

- DG-55 Drum Gauge
- 169 Non Sparking Drum Wrench

Kit #6516 pictured  
Shown with 148 cart



- 5 year Diamond Select Warranty on pumps 1702R, 1712, 1745, 1730A
- 2 year limited warranty on meter and cart
- 1 year limited warranty on pump 1730RP

Kit	Meter	Pump	Pump Ratio
6516	1520	1702R	3:1
6518	1522	1702R	3:1
6540	1515	1702R	3:1
6413	1504	1702R	3:1
6908	1520	1712	3:1
6906	1522	1712	3:1
6907	1515	1712	3:1
6905	1504	1712	3:1
6522	1520	1745	5:1
6523	1522	1745	5:1
6519	1515	1745	5:1
6504	1504	1745	5:1
6912	1520	1730A	5:1
6910	1522	1730A	5:1
6911	1515	1730A	5:1
6909	1504	1730A	5:1
6511	1520	1730RP	5:1
6914	1504	1730RP	5:1
6508	1535	1730RP	5:1
6510	1515	1730RP	5:1

Pumps on Pg. 10, 15; Reels on Pg. 86; Meters on Pg. 20, 21, 22, 24; Carts on Pg. 88



Pumps: 1702R / 1745



Pumps: 1712 / 1730A



Pump: 1730RP

# OIL EQUIPMENT PACKAGES



## 5-Gallon Pump Packages

Pump Ratio 5:1

Packages come with:  
Pump, Lid, 10' Hose,  
Band Dolly, Meter/Control  
Handle



#6515 Kit  
#1730RP 5:1 Condor Pump  
#1535 Meter Non-Preset  
  
*\*As shown in package\**

#6913 Kit  
#1730R 5:1 Pump  
#1575G Control Handle  
  
*\*Replaces pump shown in package\**

#6512 Kit  
#1730A 5:1 Pump  
#1575G Control Handle  
  
*\*Replaces pump shown in package\**

#6503 Kit  
#1730RP 5:1 Condor Pump  
#1575G Control Handle  
  
*\*Replaces pump shown in package\**





## Package Comparison

### Pumps

Pump	Description
	Pumps come with air filter, regulator, air valve, quick disconnects, foot valve and bung adaptor
1702R	Diamond Selection 5-year limited warranty 3:1 ratio / for 55 gallon drums only
1745	Diamond Selection 5-year limited warranty 5:1 ratio / for 55 gallon drums only
1730R	Diamond Selection 5-year limited warranty 5:1 ratio / stub style pump can be used in other sizes of containers with different pick up tubes
1712	Diamond Selection 5-year limited warranty 3:1 ratio / stub style pump can be used in other sizes of containers with different pick up tubes
1730A	Diamond Selection 5-year limited warranty 5:1 ratio / stub style pump can be used in other sizes of containers with different pick up tubes
	Pump comes with air filter and regulator
1730RP	1-year limited warranty 5:1 ratio / can be used in other sizes of containers with different pick up tubes

### Meters

*All meters come with a 2-year limited warranty*

Meter	Description
1504	Digital meter ( <i>batteries included</i> ) Scale can be changed to pints, quarts, liters and gallons
1515	Mechanical meter ( <i>no battery</i> ) Scale cannot be changed
1520	Mechanical preset meter ( <i>no battery</i> ) Scale cannot be changed / Set dispense quantity / Auto shut-off
1522	Digital preset meter / Set dispense quantity / Auto shut-off ( <i>batteries included</i> ) Scale can be changed to pints, quarts, liters and gallons
1535	Digital meter ( <i>batteries included</i> ) Can be changed to pints, quarts, liters and gallons

# AIR OPERATED OIL PUMPS



## Piston Pump: A-Series



(1712)

Pump Not Suitable for Water Based Fluids

### Air Ratio

The *Air Ratio* describes the amount of work an Air Operated oil pump is able to do. To figure the output PSI, you multiply the first number of the ratio by the air pressure being fed into the pump. For example, if the air pressure going into a 3:1 pump is 100 PSI, then the output pressure will be 300psi.

Air Ratio	Max. Delivery Distance
1:1	25 ft
3:1	50 ft
5:1	150 ft

All accessories shown included with pump.

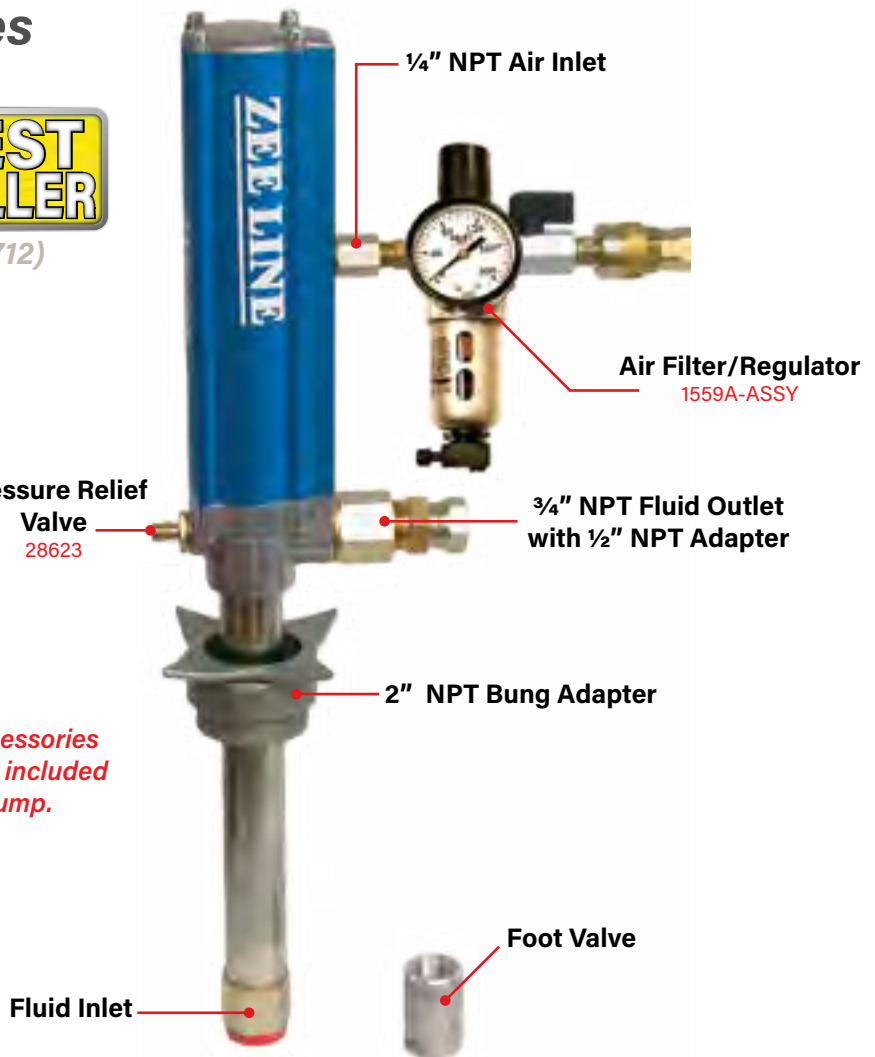

Model (Air Ratio)	1737 (1:1)	1712 (3:1)	1730A (5:1)
Max. Delivery	10.5 GPM	5.8 GPM	10 GPM
Max. Fluid Viscosity	80/90 SAE	80/90 SAE	240 SAE
Max. Fluid PSI	145 PSI	435 PSI	725 PSI
Max. Air PSI	145 PSI	145 PSI	145 PSI
Air Consumption	12.36 CFM @ 100 PSI	17.02 CFM @ 100 PSI	29.06 CFM @ 100 PSI
Air Inlet Size	1/4" NPT	1/4" NPT	1/4" NPT
Fluid Inlet Size	1" NPT	3/4" NPT	1" NPT
Fluid Outlet Size	3/4" NPT with 1/2" NPT Adapter	3/4" NPT with 1/2" NPT Adapter	3/4" NPT with 1/2" NPT Adapter

Height Dimensions	1737 (1:1)	1712 (3:1)	1730A (5:1)

\*\*Use a 5:1 ratio pump to lift fluid more than 20 feet.



All Zeeline Air Operated Pumps feature our *Diamond Selection* 5-year limited warranty.

Quality products backed by premium customer service.

**Air Operated Oil Pump Packages**

Included Parts	1737	1712	1713	1714	1716	1730A
PVC Extension	-	-	3/4" X 24" (15210) Fits 16-gal drum	3/4" X 28" (15212) Fits 55-gal drum	3/4" X 36" (15214) Fits 275-gal tote	-
Bung Adapter	28595	28585	28585	28585	28585	28595
Foot Valve	200-171	770-433	770-433	770-433	770-433	200-171
Misc.	-	-	16gal Drum Cover 680-823	-	-	-

**Above Packages also include:**

- 4' Air Hose (2004)
- 4' Oil Hose (2204)
- Air Regulator (1559A-ASSY)
- Pressure Relief Valve (28623)

**Available Accessories:**

**1/2" Oil Hoses**

- 1/2" I.D. Fiber Braid
- Max. Pressure 1,125-lbs.
- Min. Burst Pressure 4,500-lbs.
- Pressure fittings 1/2" NPT (M) both ends.



Part #	Length
2204	4'
2205	5'
2210	10'
2215	15'
2220	20'
2225	25'
2250	50'

**Oil Reels**

- All steel construction
- Dual arm support
- Durable powder coated finish
- Max. Pressure 2500 PSI
- Inlet Thread 1/2" NPT (F)
- Outlet Thread 1/2" NPT (M)
- See Pg. 86 for more details
- Compatible with ALL Zeeline oil pumps

Part #	Length
1475R	32'
1444R	49'



**PVC Pickup Tubes**

Part #	Container	Dimensions	Compatible Pump
15219	16 gallon	1" x 24"	1737, 1730A
15221	55 gallon	1" x 28"	1737, 1730A
15222	275 gallon	1" x 36"	1737, 1730A

**91**

- Wall Mount Bracket with 2" bung hole



**92**

- Suction Kit



Hose is 3/4" x 5"  
(Includes 1" bushing adapter)



## A-Series: Power Pump Valves

ORDERS MUST SPECIFY "LOCKING" OR "NON-LOCKING" SPIGOTS

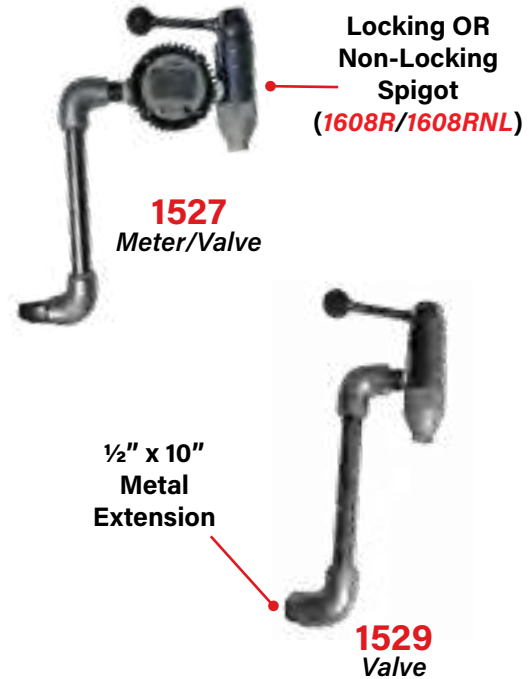

Model	1712PPV	1722
Oil Pump	1714 (3:1)	1714 (3:1)
Power Pump Valve	Power Pump Valve (1527)	Power Pump Valve (1529)
Meter	In-Line Meter (1531)	No Meter
Max. Delivery	5.8 GPM	5.8 GPM
Max. Fluid Viscosity	80/90 SAE	80/90 SAE
Max. Fluid PSI	435 PSI	435 PSI
Air Consumption	17.02 CFM @ 100 PSI	17.02 CFM @ 100 PSI
Air Inlet	1/4" NPT	1/4" NPT
Fluid Inlet	3/4" NPT	3/4" NPT
Fluid Outlet	3/4" NPT (w/ 1/2" NPT Adapter)	3/4" NPT (w/ 1/2" NPT Adapter)
Stub Pump Length	21 1/2"	21 1/2"

### Features for (1531) meter:

- Display rotates 90°
- Registers in pints, quarts, gallons, liters
- Totalizes in gallons or liters
- Easy to read dial
- Battery 3v Lithium (CR2450)

### (1712PPV) & (1722) include:

- 4' Air Hose (2004)
- 4' Oil Hose (2204)
- Air Filter/Regulator (1559A-ASSY)
- Bung Adapter (28585)
- Foot Valve w/Screen (770-433)
- 28" Pick-Up Tube (15212)
- Pressure Relief Valve (28623)



### Spigot Only

- Locking: 1608R
- Non-Locking: 1608RNL



# OIL DISPENSING STATIONS



## Oil Bars

### Dispensing Stations

Oil Taps and Oil Bars are ideal for setting up Oil Dispensing Stations. Measures can be brought to the stations and filled to the desired amount, then taken to the vehicle and dispensed accordingly.

**ORDERS MUST SPECIFY "LOCKING" OR "NON-LOCKING" SPIGOTS**

### Non-Metered



### Metered



#### Features for All Models:

- Anti-splash filter on oil tap
- Self Closing or Lock Open spigots
- Easy to clean removable drip tray

#### Size:

- Height: 26 ½"
- Width: 22"
- Depth: 17"

#### Available Configurations: **Locking**

Model	# of Taps	# of Meters
1610R	1	-
1620R	2	-
1630R	3	-
1615R	1	1
1625R	2	2
1635R	3	3

#### Available Configurations: **Non-Locking**

Model	# of Taps	# of Meters
1610RNL	1	-
1620RNL	2	-
1630RNL	3	-
1615RNL	1	1
1625RNL	2	2
1635RNL	3	3

#### Optional Accessories:

- Spigot Kit for additional oil taps (**16110R**). Includes (**1608R Locking**)
- Spigot and Meter Kit for additional oil taps w/meter (**16111R**). Includes (**1608R Locking**)
- 30" Hose (**HS1600**)

#### HS1600



#### 1504AR

- ALL Metered Oil bars include (**1504AR**)
- Dispenses in: Pints, Quarts, Liters, and Gallons
- Totalizes in: Gallons or Liters



# AIR OPERATED OIL PUMPS



## Piston Pump: R- Series

Air Ratio	Max. Delivery Distance
1:1	25 ft
3:1	50 ft
5:1	150 ft

### All three models include:

- 4' Air Hose (2004)
- 4' Oil Hose (2204)
- Air Regulator (1559A-ASSY)
- Bung Adapter (38042)
- Foot Valve (KR3308)

### Optional PVC Pickup Tubes:

Part #	Container Size	Extension
15219	16 - gallon drum	PVC 1" X 24"
15221	55 - gallon drum	PVC 1" X 28"
15222	275 - gallon drum	PVC 1" X 36"

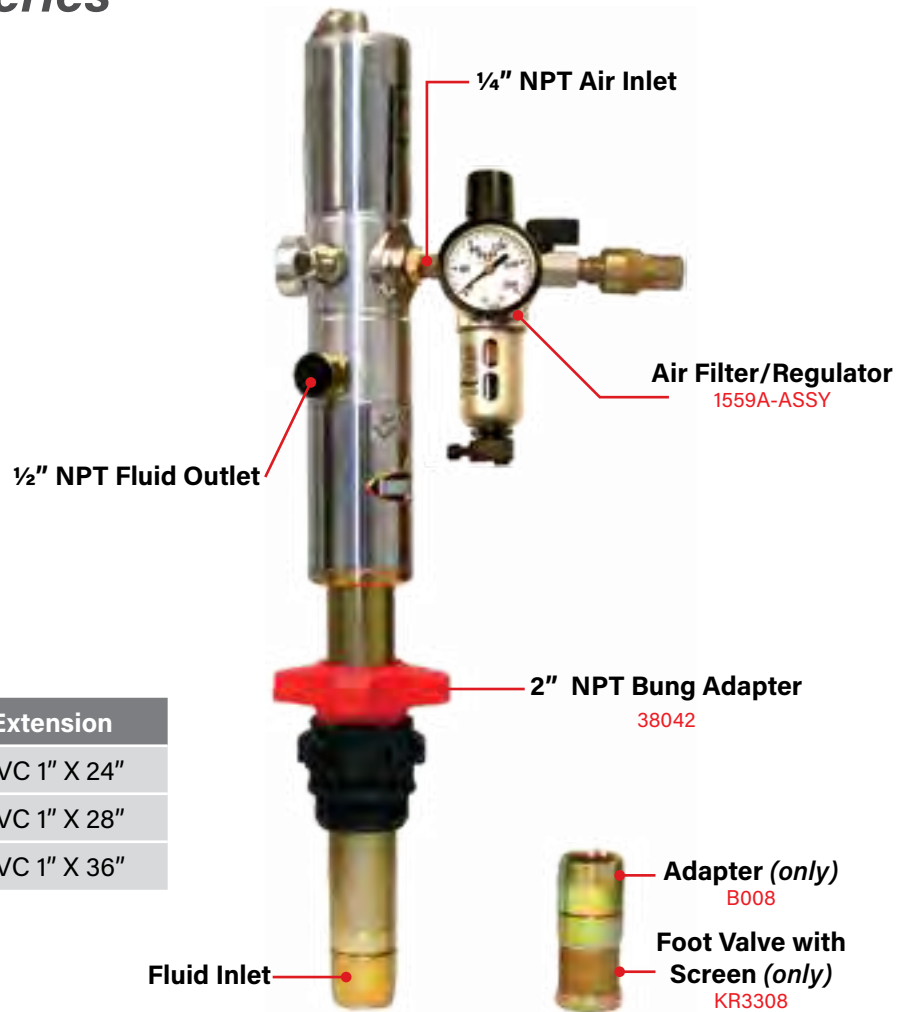

Model (Air Ratio)	1735R (1:1)	1700R (3:1)	1730R (5:1)
Max. Delivery	6 GPM	3.7 GPM	4.7 GPM
Max. Fluid Viscosity	80/90 SAE	80/90 SAE	240 SAE
Max. Fluid PSI	110 PSI	330 PSI	550 PSI
Max. Air PSI	110 PSI	110 PSI	110 PSI
Air Consumption	13 CFM @ 100 PSI	11.65 CFM @ 100 PSI	12.36 CFM @ 100 PSI
Air Inlet Size	1/4" NPT	1/4" NPT	1/4" NPT
Fluid Inlet Size	1" NPT	1" NPT	1" NPT
Fluid Outlet Size	1/2" NPT	1/2" NPT	1/2" NPT
Height Dimensions			

# AIR OPERATED OIL PUMPS

## Piston Pump: R- Series

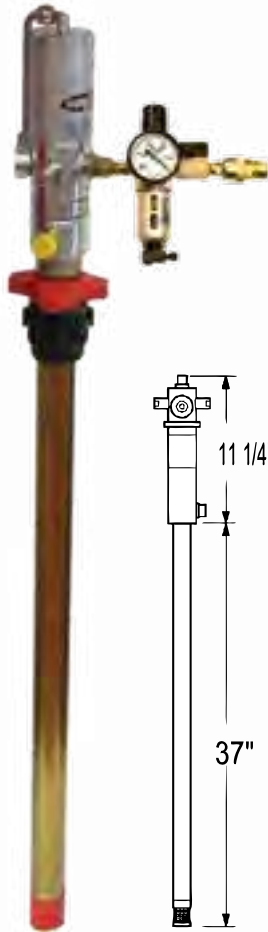

**1702R**

### Fixed Length Pumps

These pumps are designed to fit a 55 gallon drum and made to work without a PVC extension. The pickup tubes are built into the air motor and can not be shortened or extended.



*All Air Operated Pumps feature a 5 Year Limited Warranty.*

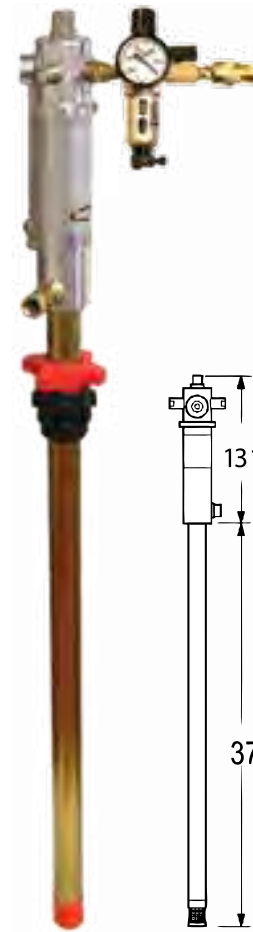

**1745**

Model (Air Ratio)	1702R (3:1)	1745 (5:1)
Max. Delivery	3.7 GPM	4.7 GPM
Max. Fluid Viscosity	80/90 SAE	240 SAE
Max. Fluid PSI	330 PSI	550 PSI
Max. Air PSI	110 PSI	110 PSI
Air Consumption	11.65 CFM @ 100 PSI	12.36 CFM @ 100 PSI
Air Inlet Size	1/4" NPT	1/4" NPT
Fluid Inlet Size	1" NPT	1" NPT
Fluid Outlet Size	1/2" NPT	1/2" NPT
Pump Length	48 1/4"	50 1/2"

### (1702R) & (1745) Include:

- 4' Air Hose (2004)
- 4' Oil Hose (2204)
- Air Regulator (1559A-ASSY)
- Bung Adapter (38042)
- Foot Valve (KR3308)

### Optional Accessory (28625): Pressure Relief Valve

- Highly recommended for ALL R-Series pumps
- Prevents damaging back pressure on pumps, meters, and reels



# AIR OPERATED OIL PUMPS



## Double Diaphragm Pumps Non-stalling, Lube-free

Pumps Not Suitable  
for Flammable Liquids



**1035**



**1038**



**(1040)**



**1040**

Model	1035	1037**	1038	1040	1040UL	1040SS
<b>Inlet/Outlet</b>	½" NPT	1½" In / 1¼" Out	¾" NPT	1" NPT	1" NPT	1" NPT
<b>Max. Flow</b>	14 GPM	14 GPM	14 GPM	37 GPM	45 GPM	37 GPM
<b>Body Construction</b>	Polypropylene	Polypropylene	Alum / Polypro	Alum / Polypro	Aluminum	Stainless Steel
<b>Diaphragms</b>	Buna N	Buna N	Buna N	Buna N	Buna N	PTFE
<b>Balls</b>	PTFE	PTFE	PTFE	PTFE	Buna N	PTFE
<b>Seats</b>	Polypropylene	Polypropylene	Aluminum	Aluminum	PTFE	PTFE
<b>UL Listed</b>	No	No	No	No	Yes	No
<b>Air Consumption</b>	16CFM @ 100 PSI	16CFM @ 100 PSI	16CFM @ 100 PSI	40CFM @ 80 PSI	25CFM @ 50 PSI <b>MAX PRESSURE 100 PSI ½" Air Inlet</b>	40CFM @ 80 PSI
<b>Bolt Pattern</b>	4.375" X 6.750"	4.375" X 6.750"	3.250" X 4.370"	4.250" X 8.250"	4.250" X 8.250"	4.250" X 8.250"
<b>Height</b>	10.600"	10.600"	10.250"	14.125"	15.125"	14.125"

\*\*Model #1037 includes two ½" x 4' oil hoses (2204), and an Air Line Filter assembly (1559A2-ASSY).

All Air Operated Pumps feature a 5 Year  
Limited Warranty.



### 1040UL

- Includes a grounding cable and is recommended for Gasoline and Diesel

### 1040SS

- Recommended for Diesel, Bio Diesel, and other mild chemicals

When pumping flammable  
liquids, use proper grounding!

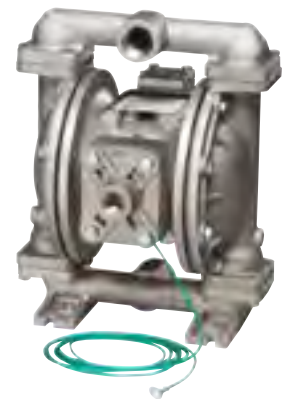



# AIR OPERATED OIL PUMPS

## Available Kits and Accessories



**103501**



**104001**



**1035K / 1040K**

### Pump Kits & their Contents

Description	Qty	103501	104001	1035K	1035K2	1040K
Compatible Pump	-	1035	1040	1035	1035	1040
Included Pump	1	None	None	1035	1035	1040
Male Cam Lock	1	3/4" (61961)	1" (61962)	3/4" (61961)	3/4" (61961)	1" (61962)
Female Cam Lock	1	3/4" (61921)	1" (61922)	3/4" (61921)	3/4" (61921)	1" (61922)
Brass Ball Valve	3	3/4"	1"	3/4"	3/4"	1"
Hydraulic Adapter Swivel	2	1/2" x 3/4"	1" x 1"	1/2" x 3/4"	1/2" x 3/4"	1" x 1"
Galvanized Steel Street L	1	3/4"	1"	3/4"	3/4"	1"
Suction Hose	1	3/4" x 8'	1" x 8'	3/4" x 8'	3/4" x 8'	1" x 8'
Discharge Hose	1	3/4" x 8'	1" x 8'	3/4" x 8'	3/4" x 8'	1" x 8'
Nipple	2	3/4" x 2"	1" x 2"	3/4" x 2"	3/4" x 2"	1" x 2"
Strainer	1	3/4"	1"	3/4"	3/4"	1"
Wall Mount Bracket (96)	1	Yes	Yes	Yes	Yes	Yes
Airline Filter (1559A2-ASSY)	1	Yes	Yes	Yes	Yes	Yes
Reducer Bushing (1035RB)	1	No	Yes	No	Yes	Yes

### 98

- Diaphragm Pump Adapter
- Mounts directly to a 2" NPT bung on drums and tanks
- Includes locking nut (**104006G**)
- Compatible with **1035** only



**Adapter Kits: Kits include (1035) Diaphragm Pump**

Kit #	Pump Hose	Control Handle
9810	10' (2210)	1572G
9825	25' (2225)	1572G

### 96

- Wall Mount Pump Bracket
- 6" Wide x 11" Deep
- Comes with mounting hardware for diaphragm pump



### 1559A2-ASSY

- Airline filter with nighttime drain, regulator, gauge, ball valve, and quick disconnects



# AIR OPERATED OIL PUMPS



## Double Diaphragm Pumps High-Flow Industrial

Pumps Not Suitable  
for Flammable Liquids

- 1 1/2" suction
- 1 1/4" discharge



1041



1043



1044

Model	1041	1043	1044
Inlet/Outlet	1 1/4" NPT	2" NPT	3" NPT
Max. Flow	70 GPM	160 GPM	260 GPM
Air Inlet Port	1/2" NPT	1/2" NPT	1/2" NPT
Max Particle Size	3/16"	1/4"	3/8"
Suction Lift - Dry	15'	20'	20'
Suction Lift - Wet	25'	25'	25'
Body Construction	Aluminum	Aluminum	Aluminum
Diaphragms	Buna N	Buna N	Buna N
Balls	Buna N	Buna N	Buna N
Seats	Buna N	Buna N	Buna N
UL Listed	No	No	No
Air Consumption	50CFM @ 80 PSI	100CFM @ 100PSI	100CFM @ 100 PSI
Bolt Pattern	6.00" X 8.750"	10.00" X 9.00"	10.00" X 14.250"
Height	18.00"	26.500"	32.750"



All Air Operated Pumps feature a 5 Year  
Limited Warranty.

# AIR OPERATED OIL PUMPS

## Vacuum Pump: Industrial Shop-Vac



**Pumps Not Suitable  
for Flammable Liquids**

### Industrial Shop-Vac

The 1785 is not an oil pump. It is used to fill a container rather than emptying one. The depiction below shows a man removing the residual sludge from a bulk storage tank and filling a 55-gallon drum with it. The 1785 must be attached to a sealed container to generate vacuum. Be careful when increasing the air pressure. If too much pressure is used, the vacuum generated is powerful enough to crumple a steel drum.



### 1785

- Converts 55 or 120-gallon container into a recovery tank.
- No moving parts.
- Automatic shutoff when container is full.

#### Applications:

- Waste oil transfer / Cutting fluids
- Paint booth water boxes
- Marinas and many other industrial uses

**Pump must be attached to a SEALED container to generate suction.**

### 108-5110

- 5-gallon recovery container
- Heavy-duty construction
- 2" NPT Bung Opening



## Preset Meters: Digital

### Preset Meter

A preset meter allows you to program the amount of fluid you want to dispense, setting it to where the meter will shut off once it has dispensed that amount.



**1517**



**1522**

Model	1517	1522
Dispenses	Pints, Quarts, Liters, and Gallons	Pints, Quarts, Liters, and Gallons
Totalizes	Pints, Quarts, Liters, and Gallons	Pints, Quarts, Liters, and Gallons
Inlet/Outlet	1/2" NPT Threads	1/2" NPT Threads
Nozzle	Flexible w/Automatic Non-Drip Tip	Rigid w/Automatic Non-Drip Tip
Max. PSI	725 PSI	1000 PSI
Max. Flow	4 GPM	8 GPM
Accuracy	± 1%	To Second Decimal
Batteries	2 AAA	4 AA
Inlet Swivel	1/2" NPT (N/A)	1/2" NPT (64082-001)
Safety Lock	Yes	Trigger Guard

# METERED CONTROL HANDLES



OIL

## Preset Meters: Mechanical

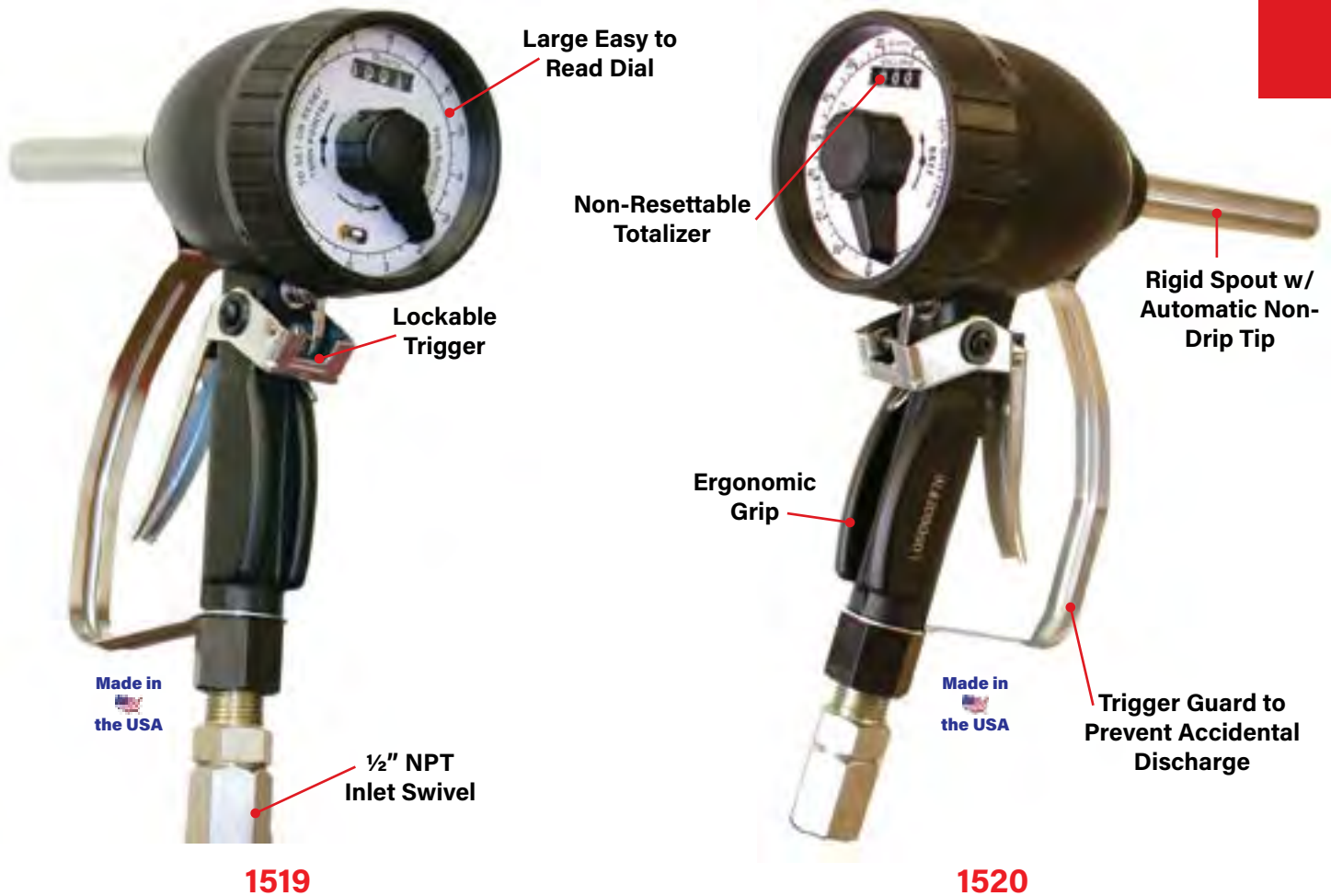

1519

1520

Features above are for all models listed below.

Model	1519	1519L	1520	1520L	1520GG
Dispenses	Quarts	Liters	Quarts	Liters	Gallons
Totalizes	Quarts	Liters	Gallons	Liters	Gallons
Preset	1-16 Quarts	1-16 Liters	1-60 Quarts	1-60 Liters	1-60 Gallons
Graduated	½ Quarts	½ Liters	Quarts	Liters	Gallons
Inlet/Outlet	½" NPT Threads	½" NPT Threads	½" NPT Threads	½" NPT Threads	½" NPT Threads
Nozzle	½" Pipe, Automatic Non-Drip (1340)	½" Pipe, Automatic Non-Drip (1340)	½" Pipe, Automatic Non-Drip (1340)	½" Pipe, Automatic Non-Drip (1340)	½" Pipe, Automatic Non-Drip (1340)
Max. PSI	1000 PSI	1000 PSI	1000 PSI	1000 PSI	1000 PSI
Max. Temp.	150°	150°	150°	150°	150°
Max. Flow	4.0 GPM	4.0 GPM	4.0 GPM	4.0 GPM	4.0 GPM
Min. Flow	0.4 GPM	0.4 GPM	0.4 GPM	0.4 GPM	0.4 GPM
Accuracy	±0.65%	±0.65%	±0.65%	±0.65%	±0.65%
Inlet Swivel	½" NPT (1101)	½" NPT (1101)	½" NPT (1101)	½" NPT (1101)	½" NPT (1101)

## Digital Meters: Non-Preset

### Non-Preset Meter

A Non-Preset Meter will display the amount of fluid being dispensed, but will not shut off automatically. The dispensing total can be reset for every use.

**BEST  
SELLER**

(1504)



Made in  
the USA

1504



Made in  
the USA

1507

Shroud part #  
66339-001



Made in  
the USA

1509



**NEW**

1535

Model	1504	1507	1509	1535
Dispenses	Pints, Quarts, Liters, and Gallons	Pints, Quarts, Liters, and Gallons	Pints, Quarts, Liters, and Gallons	Pints, Quarts, Liters, and Gallons
Totalizes	Liters and Gallons	Liters and Gallons	Liters and Gallons	Liters and Gallons
Inlet/Outlet	½" NPT Threads	½" NPT Threads	½" NPT Threads	½" NPT Threads
Nozzle	½" Flex Hose, Automatic Non-Drip (1315A)	½" Flex Hose, Manual Non-Drip (1315)	½" Pipe, Automatic Non-Drip (1340)	½" Flex Hose (1315A) Automatic Non-Drip
Max. PSI	1500 PSI	1500 PSI	1500 PSI	1500 PSI
Temp. Range	-4° F to 140° F	-4° F to 140° F	-4° F to 140° F	-4° F to 140° F
Max. Flow	4.0 GPM	4.0 GPM	4.0 GPM	4.0 GPM
Min. Flow	0.4 GPM	0.4 GPM	0.4 GPM	0.4 GPM
Accuracy	±0.5%	±0.5%	±0.5%	±0.5%
Inlet Swivel	½" NPT (1572GSW)	½" NPT (1572GSW)	½" NPT (1101)	½" NPT (1572GSW)

### Features for all models:

- Resettable dispenser
- Non-resettable totalizer
- Cast aluminum housing
- Scratch resistant oven baked epoxy finish
- Easy to read 6 digit LCD with .01 increment
- Long life field replaceable top load battery (CR123A)

### 1504AR

- Meter Only



Outlet

Inlet

# METERED CONTROL HANDLES



## Digital Meters: Non-Preset

### High-Flow Meter

#### 1590AR

- Meter Only

#### 1590

- 20 GPM
- Oval gear driven design
- Large LCD display with two decimal point precision
- Field replaceable battery
- Optional rubber boot (66339-001)

**Note:**  
Glycol for 1590 & 1531 digital meters only

Model	1590
Max. Flow	20.0 GPM
Dispenses	Pints, Quarts, Liters, and Gallons
Totalizes	Gallons or Liters
Inlet/Outlet	3/4" NPT Threads
Nozzle	Flexible Hose w/Automatic Non-Drip Tip
Control Handle	Included (33150)
Handle Adapter	Included (33117)
Temp Range	4° F to 140° F
Accuracy	±0.5%
Inlet Swivel	3/4" NPT (38065)



Made in  
the USA

### In-Line Meters:



#### 1531

- Digit Non-Resettable Totalizer
- Electronic Display using one 3V lithium Ion Battery with life up to 2 years
- Display can be rotated in every 90° orientation
- Measures in Gal, Qts, Pts, Litres



#### 1502

- For dispensing up to 8 pints
- Registers in 1/4 pint increments

Made in  
the USA



#### 1500

- For dispensing up to 8 pints
- Registers in 1/4 pint increments

Made in  
the USA



#### 1505

- For dispensing and totalizing up to 16 quarts
- Registers in 1/4 quart increments

Made in  
the USA

# METERED CONTROL HANDLES

## Mechanical Meters: Non-Preset/In-Line

Inlet/Outlet	Max. Flow	Min. Flow	Max. PSI	Max. Temp	Accuracy	Dial Size	Swivel
½" NPT	4.0 GPM	0.25 GPM	1000 PSI	150° F	±0.65%	3 ½"	½" NPT (1101)



Model	Dispenses	Totalizes	Dial Reads	Graduated	Nozzle
1508	Quarts	Quarts	1-16 Quarts	¼ Quarts	1340
1508L	Liters	Liters	1-10 Liters	⅒ Liters	1340
1508Q	Quarts	Quarts	1-16 Quarts	¼ Quarts	1335
1508G	Quarts	Gallons	1-16 Quarts	¼ Quarts	1340
1508GG	Gallons	Gallons	1-16 Gallons	¼ Gallons	1340
1515	Quarts	Quarts	1-16 Quarts	¼ Quarts	1315
1515L	Liters	Liters	1-10 Liters	⅒ Liters	1315
1515A	Quarts	Quarts	1-16 Quarts	¼ Quarts	1315A
1515G	Quarts	Gallons	1-16 Quarts	¼ Quarts	1315
1515GG	Gallons	Gallons	1-16 Gallons	¼ Gallons	1315



# METERED CONTROL HANDLES



## Mechanical Meters: Non-Preset

Inlet/Outlet	Max. Flow	Min. Flow	Max. PSI	Max. Temp	Accuracy	Dial Size
1/2" NPT	4.0 GPM	0.25 GPM	1000 PSI	150° F	±0.65%	3 1/2"



Made in  
the USA

**1503**



**1525G**

Meter Only



**1525AR**

Model	1503	1525G
Dispenses	Pints	Quarts
Totalizes	Pints	Quarts
Inlet/Outlet	1/2" NPT Threads	1/2" NPT Threads
Shroud	Optional (59628-001)	Standard
Nozzle	90° Pipe w/Manual Tip (1326)	Flex Hose w/Automatic Non-Drip Tip (1315A)
Handle	Integrated	Control Handle (1572G)
Swivel	1/2" NPT (1101)	1/2" NPT (1572GSW)



**786**

- Wall mounted oil meter holder and drip tray
- Used to catch drips from hanging oil meters

**All Zeeline Oil Meters and Control Handles, mechanical and digital, feature a 2-year limited warranty.**

**Quality products backed by premium customer service.**

# NON-METERED CONTROL HANDLES

## Control Handle Accessories



**1572G**



Replaces (1587)

**1575G**



**1580G**

### Control Handle Body:

**1572GAR**

- Rugged Aluminum Body
- Slimline Ergonomic Design
- Inlet: 1/2" NPT
- Outlet: 1/2" NPT
- Includes 1/2" NPT Swivel (1572GSW)



### Tips:

**26**



- Manual Non-Drip Nozzle
- 1/4" NPT

**26A**



- Automatic Non-Drip Nozzle
- 1/4" NPT



**1572GSW**

- 1/2" NPT Swivel

### Nozzles and Spouts:



**1315**



**1315A**



**1330**



**1335**



**1340**



**1326**

Model	1315	1315A	1330	1335	1340	1326
Description	14" Flex-Hose w/Manual Non-Drip Nozzle (26)	14" Flex-Hose w/Automatic Non-Drip Nozzle (26A)	8" 30° Bent Pipe w/Manual Non-Drip Nozzle (26)	8" 15° bent pipe w/Manual Non-Drip Nozzle (26)	6" Straight Pipe with Automatic Non-Drip Nozzle (N/A)	6" 90° Bent Pipe w/Manual Non-Drip Nozzle (26)
Thread Size	1/2" x 1/4" NPT	1/2" x 1/4" NPT	1/2" x 1/4" NPT	1/2" x 1/4" NPT	1/2" NPT	1/2" x 1/4" NPT

# TOTE MOUNTED EQUIPMENT

## Tote Mounting Plate & Kits

### Universal Tote Mounting Plate



#### 6601

- Fits totes 39" to 41" wide; most 275 to 330-gallon totes
- Clamps to side rails of most shaped cages
- Steel construction with a scratch resistant powder coated finish
- 2" NPT threads for pump
- 2" filler neck with rubber cap
- Holes for mounting Zeeline reels
- Shipping Weight: 24lbs.
- Shipping Dimensions: 7" x 16" x 45"



*Tote Not Included*

Kit #	Pump	Reel / Hose	Meter / Handle
6611	3:1 Stub (1712)	32' Reel (1475R)	Mechanical (1525G)
6612	3:1 Stub (1712)	32' Reel (1475R)	Mechanical (1515)
6613	3:1 Stub (1712)	25' Hose (2225)	Digital Quart (1504)
6614	3:1 Stub (1712)	32' Reel (1475R)	Digital Quart (1504)

*Kits include a Tote Bracket (6601), and Suction Tube (15216).*

**Other kits available.**

# ELECTRIC OIL PUMP

## And Portable Dispensing Systems



### Features for Both (936G) & (938G):

- Pickup tube with built in screen for 55 gallon container
- Built in bypass valve with on and off switch
- Self-priming, positive displacement
- Air cooled motor with thermal protection

Model	936G	938G
Delivery Rate	4.4 GPM	8 GPM
Max. Oil Viscosity	90-wt. @ 50° F	90-wt. @ 50° F
Inlet	1" NPT	1" NPT
Outlet	¾" NPT	¾" NPT
Discharge Hose	¾" x 8'	¾" x 8'
Suction Tube	34" Steel	34" Steel
Motor	½ HP 115-Volt AC	½ HP 115-Volt AC
Max. Oil Temp.	150° F	150° F
Max. Outlet PSI	65 PSI	65 PSI
RPM	1720 RPM	3400 RPM



## Portable Oil Dispensing Systems:



### 3024

- 5-gallon wheel mounted tank for modern workplaces
- No pump needed
- Maximum air pressure 100 PSI
- Delivery hose and control handle
- Loading funnel features and anti-splash rim
- Level gauge



### 5265

- 17-gallon wheel-mounted tank
- 3:1 ratio pump (dispenses 3.7 GPM @ 90 PSI)
- Maximum air pressure 110 PSI
- Air consumption 12 CFM @ 100 PSI
- Digital meter (1504)
- Delivery hose (13' length, ½" diameter)
- 3" front and 6" rear wheels with ball bearings
- Loading funnel features and anti-splash rim
- Level gauge

Pumps Not Suitable for Flammable Liquids, Water Based Liquids, or Corrosive Liquids.

**BEST SELLER**

(321)



**321**

**Gear Lube Pump**

- For dispensing oils, ATF, and gear lube (max 140-wt.)
- Delivers approximately 1-gallon per 55 strokes
- Variable stroke handle
- Powder coated pail cover
- 4' vinyl hose with curved nozzle
- Buna N seal



**101**

**Suction Gun**

- 17-oz. Capacity
- 12" clear vinyl hose
- Powder-coated steel construction
- Buna N piston ring



**353**

**Plastic Bucket Pump**

- Attaches directly to pull-up spout on many 5-gallon pails, without a need to remove the plastic covers
- Includes 7 pump adapters for all types of pails
- Dispenses approximately 1-QT per 19 strokes
- Discharge hose is fitted with a non-drip tip
- Includes an extension for a 6 1/2-gallon pail
- 48" long hose with embedded spring
- Plastic pump head and steel tube
- Metal curved pump spout
- Down-stroke operation



# HAND PUMPS

## For 15-55 Gallon Drums



Pumps Not Suitable for Water Based Fluids



### Features for all models:

- Variable stroke
- Durable powder coated finish

(381) & (382):

- Steel body with die cast aluminum head and base

(D-S) & (D-S1):

- All steel body

Model	381	382	D-S	D-S1
Delivery Rate	1-gal. per 9 strokes	1-gal. per 9 strokes	1-gal. per 9 strokes	1-gal. per 9 strokes
Variable Stroke	Yes	Yes	Yes	Yes
Max Fluid Viscosity	40 wt.	40 wt.	40 wt.	40 wt.
Suction Tube	Telescoping PVC	Telescoping PVC	Telescoping PVC	Telescoping PVC
Non-Drip Tip	No	Yes	No	Yes (D01)
Powder Coat Finish	Yes	Yes	Yes	Yes
Seals	Buna N	Buna N	Buna N	Buna N
Threads on Spout	Garden Hose	Non-Drip Spout	Garden Hose	Non-Drip Spout

### Available Accessories:

#### 104006G

- Locking nut
- Allows 360° positioning on pump
- Fits all above models



#### D01

- Non-Drip Attachment
- 3/4" GHT



#### 170

- Lever Lock
- Fits up to a 1/2" lock
- Fits most lever style drum pumps
- Lock not included



# HAND PUMPS

LIGHT OIL ATF OIL Gear Lube

OIL

## Quart Stroke

Pumps Not Suitable for Flammable Liquids, Water Based Liquids, or Corrosive Liquids.

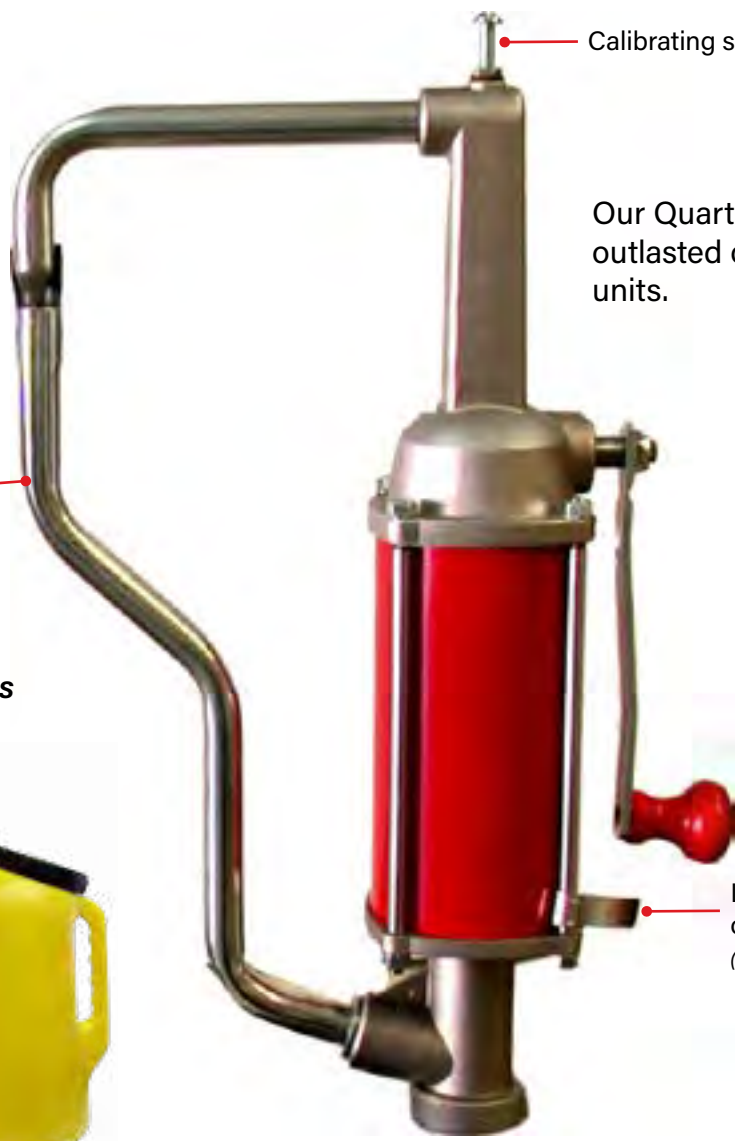

Calibrating screw.

Our Quart Stroke Pump has outlasted other manufacturer units.

Spring loaded drain back tube eliminates drips & messes.

Lock tab to lock out user.  
(No lock provided)

### Optional Accessories



780 - measures 8 quarts  
(see pg. 96)

*Ideal for dispensing the correct amount of oil each time.*



169 - Non sparking drum wrench  
(see pgs. 67, 90)

Model	975
Container Size	15 to 55 gallon
Bung Size	2" NPT
Delivery	1-quart per cycle
Lockable Crank Arm	Yes
Suction Tube	Steel Telescoping
Seals	Delrin
104006G	Locking Ring
L30-99N	Suction Tube
9752394	Rebuild Kit

# HAND PUMPS

## Lever Style



Pumps Not Suitable for Flammable Liquids, Water Based Liquids, or Corrosive Liquids.



**155**

- Fits 30 to 55-gallon drums



**15-30**

- Fits 15 to 30-gallon drums

*All pumps come with variable stroke handle positions.*



**336**

- Fits 16-gallon open head drums



**338**

- Fits 15 to 55-gallon drums

Maximum 140-wt.

Model	Hose Assembly	Bung Adapter	Approximate Delivery	Seals
155	5' (104016-A)	2" (106025)	1-gal per 32 strokes	Buna N
15-30	5' (104016-A)	2" (106025)	1-gal per 32 strokes	Buna N
336	5' (104016-A)	Cover for Drum	1-gal per 32 strokes	Buna N
338	Not Included	2" (106025)	1-gal per 32 strokes	Buna N



# HAND PUMPS

## Premium Lever Style

**Digital Meter (1531)**



**1208**

- Includes Pint meter (1531)
- Fits 16-gallon drum
- NEW Digital Meter reads pints, quarts, gallons, liters
- Totalizes in gallons/liters
- Battery CR2450



**1209**

- Does **NOT** include meter
- Fits 16-gallon drum
- See chart below for all parts included



**1209RAR**

- Pump and hose assembly only
- Fits 16 to 55-gallon drums
- See chart below for all parts included

### Features for all models:

- Recommended for oil with a viscosity of 5 to 130-wt.
- Double action pump (pumps fluid on the upward and downward stroke)
- Adjustable lever for varying oil viscosity
- First two holes near suction rod must be used for all lubes over 50-wt. Use last hole for maximum delivery
- Buna N seals
- Plated carbon steel construction
- Steel telescoping suction tube
- Bung adapter
- Hose (KC283)

**Pumps Not Suitable for Flammable Liquids, Water Based Liquids, or Corrosive Liquids.**

Model	1208	1209	1209RAR
<b>Delivery</b>	1-gal. per 32 strokes	1-gal. per 32 strokes	1-gal. per 32 strokes
<b>Container Size</b>	16-gallon drum	16-gallon drum	16 to 55-gallon drum
<b>Discharge Hose</b>	5' delivery hose	5' delivery hose	5' delivery hose
<b>Drum Cover</b>	680-823	680-823	None
<b>Drum Dolly</b>	120-S	120-S	None
<b>Meter</b>	1531	None	None

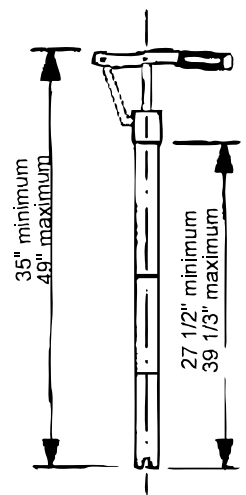

# HAND PUMPS

## Lift Style



Pumps Not Suitable for  
Water Based Fluids



### 366

- Fits 15 to 55-gallon drums
- Recommended for light oil products



Retail Packaging



### 366T

- Fits 15 to 55-gallon drums
- Recommended for paint thinners and some non-corrosive chemicals

#### Maximum 140-wt.

Model	366	366T
Delivery Rate	1-gallon per 6 lift strokes	1-gallon per 6 lift strokes
Container Size	15 to 55-gallon drum	15 to 55-gallon drum
Length	37 1/2"	37 1/2"
Seal	PTFE	PTFE
Bung Adapter	Powder Coated	Unpainted

#### Features both models:

- Plated steel construction with die cast aluminum head
- Heavy-duty bar stock handle
- Cast iron bung adapter for a durable long lasting thread
- Garden hose threads on the head of the pump allow for a threaded connection
- Brass piston ring allows for smooth operation without deterioration

# WASTE OIL DRAINS

## Low Profile Truck Drains



### 234

- For draining oil or antifreeze from heavy-duty trucks and RVs where a lift drain is not suitable
- Four 4" swivel casters provide excellent maneuverability
- Heavy-duty polyethylene construction
- 6' discharge hose with steel nozzle
- Black wire mesh screen
- 17-gallon capacity
- Dimensions: H- 7.75" W- 34 11/16" L- 46.5"
- *Ships freight only / 50 lbs shipping weight*



### 237 (w/pump)

- For draining oil or antifreeze from heavy-duty trucks and RVs where a lift drain is not suitable
- Four 4" swivel casters provide excellent maneuverability
- Heavy-duty polyethylene construction
- 6' discharge hose with steel nozzle
- Black wire mesh screen
- 17-gallon capacity
- Dimensions: H- 7.75" W- 34 11/16" L- 46.5"
- *Ships freight only / 55 lbs shipping weight*

#### Included Evacuation Kit (236G):

- 115V UL Listed Pump
- Rubber discharge hose



### 227

- For draining oil or antifreeze from heavy-duty trucks and RVs where a lift drain is not suitable
- 18-gallon capacity
- Heavy-duty steel construction
- ½" NPT drain outlet
- Dimensions: H- 7.5" W- 22" L- 42"
- *Ships freight only / 85lbs shipping weight*



(227)

### 1035K2

- Air operated suction kit for draining (227)
- Includes: pump, hoses, mounting bracket, and other necessary connections.
- For complete details, see Pg. 17



## Lift/Gravity Drains

**1234**

- For gravity drain of fluids from engines, gearboxes, or differentials of all motor vehicles placed on an auto-lift or pit
- Adjustable neck with a minimum height of 53" and maximum height of 65"
- 21-gallon wheel mounted tank with front ball bearing wheels
- Centrally mounted bowl on swivel joint for positioning
- Level sight gauge: scaled in liters and gallons
- 6" x 8" x 2" removable steel tool tray

Model	1234
Collection Capacity	16-gallons (max)
Funnel	14" Diameter
Bowl	4-gallon adj. height
Draining PSI	7 PSI (Max)
Drain Hose	6 ½'
Tool Tray	6" x 8" x 2" Steel

**Features for (309), (316) & (318):**

- Translucent
- Durable polyethylene construction
- 18" polyethylene funnel (699J)
- 1 ¾" drain tube
- Adjusts from 44 ½" to 67" in height

**Optional Accessories**

- Drain Pan 24" x 24" (776)
- Drain Pan 24" x 37" (778)

Model	309	316	318
Capacity	8-gallon	8-gallon	18-gallon
Casters	No	Yes	Yes (3 ½")
Drain Valve	No	No	Yes
2" NPT Opening	No	No	Yes

**312**

- For converting 120lbs open head drum into a lift drain (*drum not included*)
- Fits 16-gallon or 120lbs open head containers
- Drum cover
- 67 ½" drain pipe
- 14" steel funnel

**Optional Accessory**

- Drum Dolly (120-S)



# WASTE OIL DRAINS

## Lift/Gravity Drains



### 1235

- 17 gallon wheel mounted tank
- Adjustable height with minimum 49" and maximum 69"

### 1236

- 23 gallon wheel mounted tank
- Adjustable height with minimum 55" and maximum 75"

### Features for Both Models:

- Centrally mounted bowl on swivel joint for positioning
- Front and rear ball bearing wheels (3" front casters and 6" rear wheels)
- Level sight gauge: scale in liters and gallons
- Anti-splash screen/filter provides useful support for draining used filters

Model	1235	1236
<b>Collection Capacity</b>	13.7-gal (Max)	19.7-gal (Max)
<b>Funnel</b>	22 1/2" Diameter	22 1/2" Diameter
<b>Bowl</b>	3 1/2-gal adj. height	3 1/2-gal adj. height
<b>Draining PSI</b>	7 PSI (Max)	7 PSI (Max)
<b>Drain Hose</b>	6 1/2'	6 1/2'
<b>Tool Tray</b>	6" X 8" X 2" Steel	6" X 8" X 2" Steel

# WASTE OIL DRAINS

## Oil Evacuation Units



### 1230

- 23 gallon portable unit

### 1231

- 23 gallon portable unit with funnel

### Features for Both Models:

- 2 heavy-duty 6" ball bearing rear wheels
- 2 front 3" ball bearing swivel casters
- Fluid level indicator
- Continuous connection to air source not required

### Included probes; size and type:

#### Plastic

- 1/4" X 27 1/2"
- 3/16" X 27 1/2"
- 5/16" X 27 1/2"
- 9/32" X 39 3/8"

#### Metal

- 1/4" X 27 1/2"
- 3/16" X 27 1/2"

Model	1230	1231
Tank Capacity	23-gal	23-gal
Min. Oil Temp	158° F (for suction)	
Draining PSI	7 PSI (Max)	7 PSI (Max)
Suction Hose	6 1/2' w/Probes	6 1/2' w/Probes
Drain Hose	6 1/2'	6 1/2'
Tool Tray	6" X 8" X 2" Steel	6" X 8" X 2" Steel



### 1231

# WASTE OIL DRAINS

## Pantograph Suction/Drainer

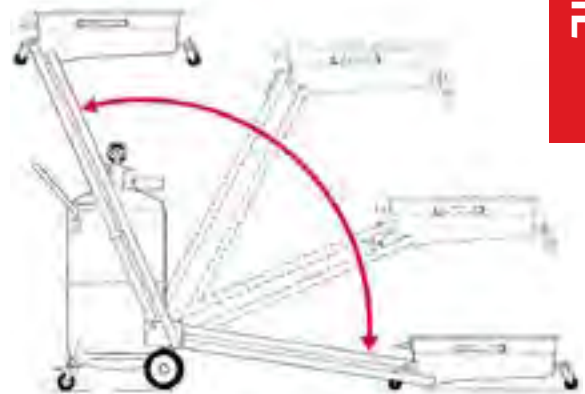

The pantograph arms allow the tank to be placed on the floor or raised, for draining under a lift.

### Overall dimensions



### 6215

- 30 gallon wheel mounted tank holds 25 gallons before draining
- Drains oil from heavy-duty trucks and RVs where a lift drain is not safely available
- Tank is equipped with level gauge and removable tool tray
- 13 gallon drain pan can be lowered to a height of 9" for rolling under cars and trucks

**This versatile 3 in 1 oil suction/drainer can be used to change oil on all types of automobiles and trucks:**

- 1) By gravity, with tank on the floor
- 2) By gravity with pan raised, with motor vehicles placed on auto lift or over a pit
- 3) By suction with probe inserted directly into the engine. A continuous connection to the compressed air line or other energy source is not required (the oil must be hot, 160-175° F)

# AIR OPERATED GREASE SYSTEMS

50lb Pail Up To No.2 NLGI

## 50:1 Ratio Pump for 25-50lb Pail

GREASE



### 3574R

- Complete system with all parts shown for pumping grease from 5 to 6-gallon buckets and 25-50lb. pails



(3574R)

Model	3574R
Pump	Heavy-Duty 50:1
Max Grease NLGI	No. 2
Max Delivery	52oz per minute @ 90PSI
Max Air PSI	110 PSI
Air Consumption	4.59 CFM @ 100 PSI
Air Inlet	1/4" NPT
Air Hose	1/4" x 4' (2004)
Tube Length	16"
Pump Tube Diameter	1 3/16"
Airline Filter Package	1559A-ASSY

### Available Packages:

Package #	Hose Length	Hose P/N
3574R	6'	1806
3574R-00	None	-
3574R-10	10'	1810
3574R-12	12'	1812
3574R-16	16'	1816
3574R-25	25'	1825



### Included Accessories:



**1559A-ASSY**  
• Regulator combination unit



**1536A**  
• Control handle



**66599**  
• Carry handle



**2004**  
• 4' Air hose



**65310**  
• Drum Cover



**1545**  
• "Z" swivel



**107016**  
• Follower plate



**1806**  
• 6' Grease hose



# AIR OPERATED GREASE SYSTEMS

## 60:1 Ratio Pump for 25-50lb Pail

50lb Pail Up To No. 2 NLGI

### 3574A

- Complete system with all parts shown for pumping grease from 5 to 6-gallon buckets and 25-50lb. pails

Model	3574A
Pump	Heavy-Duty 60:1
Max Grease NLGI	No. 2
Max Delivery	38.72 oz per minute @ 100PSI
Max Air PSI	145 PSI
Air Consumption	5.50 CFM @ 100 PSI
Air Inlet	1/4" NPT
Air Hose	1/4" x 4' (2004)
Tube Length	17 3/4"
Pump Tube Diameter	1 3/16"
Bung Adapter	2" (28591)
Airline Filter Package	1559A-ASSY



GREASE

### Available Packages:

Package #	Hose Length	Hose P/N
3574A	6'	1806
3574A-10	10'	1810
3574A-12	12'	1812
3574A-16	16'	1816
3574A-25	25'	1825

### Included Accessories:



**1559A-ASSY**  
• Regulator combination unit



**1536A**  
• Control handle



**1806**  
• 6' Grease hose



**2004**  
• 4' Air hose



**18527**  
• Drum Cover



**1545**  
• "Z" swivel



**107016**  
• Follower plate



# AIR OPERATED GREASE SYSTEMS

120lb Drum

## 65:1/50:1 Ratio Pump for 120lb Drum



### Features for Both Models:

- Complete system with all parts shown for pumping grease from 120lb drums
- Suction tube constructed with no seals to eliminate excessive wear

Model	1213R	1220R
<b>Pump</b>	Heavy-Duty 65:1	Heavy-Duty 50:1
<b>Max Grease NLGI</b>	No. 3	No. 2
<b>Max Delivery</b>	66oz per minute @ 90PSI	52oz per minute @ 90PSI
<b>Max Air PSI</b>	110 PSI	110 PSI
<b>Air Consumption</b>	8.74 CFM @ 100 PSI	4.59 CFM @ 100 PSI
<b>Air Inlet</b>	1/4" NPT	1/4" NPT
<b>Air Hose</b>	1/4" x 4' (2004)	1/4" x 4' (2004)
<b>Pump Head Diameter</b>	2 1/2"	2 1/2"
<b>Head Length</b>	10"	10"
<b>Tube Length</b>	29"	29"
<b>Pump Tube Diameter</b>	1 3/16"	1 3/16"
<b>Airline Filter Package</b>	1559A-ASSY	1559A-ASSY

### Available Packages:

Package #	Hose Length	Hose P/N	Package #	Hose Length	Hose P/N
1213R	6'	1806	1220R	6'	1806
1213R-00	None	-	1220R-00	None	-
1213R-10	10'	1810	1220R-12	12'	1812
1213R-12	12'	1812	1220R-16	16'	1816
1213R-16	16'	1816			
1213R-25	25'	1825			
1213R-50	50'	1850			

### Applications:

- For dispensing short and long distances
- Particularly suited for centralized dispensing system
- Highly recommended for specific needs requiring a higher quantity of grease and higher pressure

### Included Accessories:



**1559A-ASSY**  
• Regulator combination unit



**1536A**  
• Control handle



**1806**  
• 6' Grease hose



**2004**  
• 4' Air hose



**65385**  
• Drum Cover



**1545**  
• "Z" swivel



**1524**  
• Follower plate



**120-S**  
• Drum dolly

GREASE



# AIR OPERATED GREASE SYSTEMS

## 60:1 Ratio Pump for 120lb Drum

120lb Drum Up To No. 2 NLGI



Model	1213A & 1214A
Pump	Heavy-Duty 60:1
Max Grease NLGI	No. 2
Max Delivery	38.72 oz per minute @ 100PSI
Max Air PSI	145 PSI
Air Consumption	5.50 CFM @ 100 PSI
Air Inlet	1/4" NPT
Air Hose	1/4" x 4' (2004)
Tube Length	29 1/2"
Pump Tube Diameter	1 5/32"
Bung Adapter	2" (28591)
Airline Filter Package	1559A-ASSY

### 1213A & 1214A:

- Complete system with all parts shown for pumping grease from 120lb drums



GREASE

### Available Packages:

Package #	Hose Length	Hose P/N
1213A	6'	1806
1213A-00	None	-
1213A-10	10'	1810
1213A-12	12'	1812
1213A-16	16'	1816
1213A-25	25'	1825
1213A-50	50'	1850

### 1213A Included Accessories:



#### 1559A-ASSY

- Regulator combination unit



#### 1536A

- Control handle



#### 1806

- 6' Grease hose



#### 2004

- 4' Air hose



#### 680-823

- Drum Cover



#### 1545

- "Z" swivel



#### 1524

- Follower plate



#### 120-S

- Drum dolly

### 1214A Included Accessories:



#### 1559A-ASSY

- Regulator combination unit



#### 1806

- 6' Grease hose



#### 2004

- 4' Air hose



#### 680-823

- Drum Cover



#### 1524

- Follower plate

# AIR OPERATED GREASE SYSTEMS

400lb Drum

GREASE

## Pumps for 400lb Drums

### 1212R

- Dispenses grease from a 400lb open head drum
- Air motor with a silicone lube to eliminate the need for an oiler

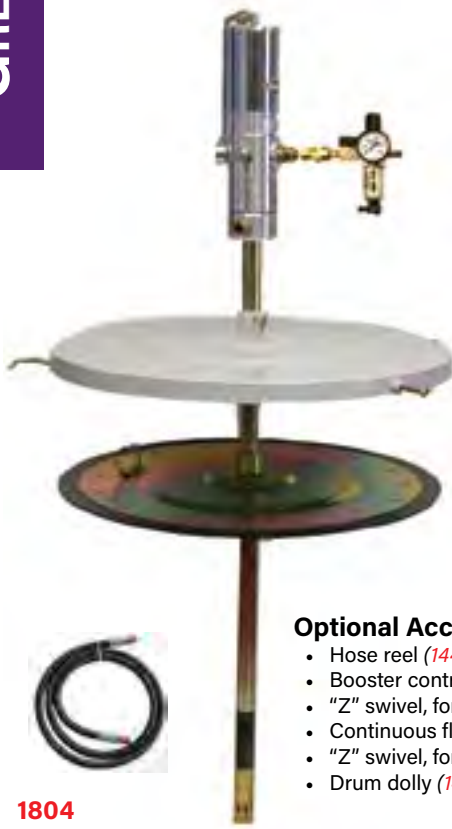

#### 1559A-ASSY

- Air regulator combination unit

#### 65600

- Drum Cover

#### 66590

- Follower plate

- Includes
- 4' grease hose
  - 4' Air supply hose

#### Optional Accessories

- Hose reel (1440R)
- Booster control handle (1536A)
- "Z" swivel, for use with (1536A) control handle, (1545)
- Continuous flow control handle (1534)
- "Z" swivel, for use with (1534) control handle, (1547)
- Drum dolly (140-S, 140-SOR)



**1804**  
• 4' Grease hose



**2004**  
• 4' Air hose

### 1212A

- Dispenses grease from a 400lb open head drum
- Air motor with a silicone lube to eliminate the need for an oiler



#### 1559A-ASSY

- Regulator combination unit



**1804**  
• 4' Grease hose



**2004**  
• 4' Air hose



**18525**  
• Drum Cover



**18573**  
• Follower plate

Model	1212R	1212A
<b>Pump</b>	Heavy-Duty 65:1	Heavy-Duty 60:1
<b>Max Grease NLGI</b>	No. 3	No. 2
<b>Max Delivery</b>	66oz per minute @ 100PSI	38.72 oz per minute @ 100PSI
<b>Max Air PSI</b>	110 PSI	145 PSI
<b>Air Consumption</b>	8.47 CFM @ 100 PSI	5.50 CFM @ 100 PSI
<b>Air Inlet</b>	1/4" NPT	1/4" NPT
<b>Air Hose</b>	1/4" x 4' (2004)	1/4" x 4' (2004)
<b>Tube Length</b>	37"	36 5/8"
<b>Pump Tube Diameter</b>	1 3/16"	1 5/32"
<b>Bung Adapter</b>	N/A	2" (28591)
<b>Airline Filter Package</b>	1559A-ASSY	1559A-ASSY

# GREASE HANDLES

## Continuous Flow and Booster Handles

### Control Handles



Pressure Relief Valve



GREASE

#### 1533

- Booster handle with pressure relief valve
- Each pull of the handle increases pressure up to 10,000 PSI

#### 1534

- Continuous flow
- Pressure is determined by the pump used with this handle

#### 1536A

- Booster handle
- Each pull of the handle increases pressure up to 10,000 PSI

Model	1533	1534	1536A
Inlet	1/8" NPT	1/4" NPT	1/8" NPT
Outlet	1/8" NPT	1/8" NPT	1/8" NPT
Continuous Flow	Yes	Yes	Yes
Grease Coupler	3-Jaw	Standard 3-Jaw (28)	Heavy-Duty 3-Jaw (25)
Pressure Relief Valve	Yes	No	No
Construction	Steel	Steel	Aluminum

### Accessories



#### 1544

- Straight swivel
- Inlet: 1/4" NPT (F)
- Outlet: 1/4" NPT (M)
- Compatible with: 1534



#### 1547

- "Z" Swivel
- Inlet: 1/4" NPT (F)
- Outlet: 1/4" NPT (M)
- Compatible with: 1534



#### 1545

- "Z" Swivel
- Inlet: 1/4" NPT (F)
- Outlet: 1/8" NPT (M)
- Compatible with: 1533, 1536A

#### 17



- Flexible hose assembly for use with control handles
- Includes adapter, hose, and coupler
- Working pressure 5,000 PSI
- Burst pressure 20,000 PSI

# FOLLOWER PLATES

## Straight or Tapered

Steel follower plates suitable for barrels, drums, and pails (straight or tapered).

GREASE



**107012/107016**



**1524**



**18573**

Part #	Description	Ideal For	I.D.	O.D.
<b>For 25-50lb Pails</b>				
<b>107012</b>	Flexible rubber edge	<b>328</b> (Pg. 49)	1.50"	11.25"
<b>107016</b>	Flexible rubber edge	<b>3574A</b> (Pg. 41) <b>3574R</b> (Pg. 40)	1.16"	11.375"
<b>For 120lb Drums</b>				
<b>1523</b>	Steel edge	<b>327</b> (Pg. 49)	1.437"	14.25"
<b>1524</b>	Flexible rubber edge	<b>1213R</b> (Pg. 42) <b>1220R</b> (Pg. 42) <b>1213A</b> (Pg. 43)	1.25"	15.00"
<b>For 400lb Drums</b>				
<b>18573</b>	Flexible rubber edge	<b>1212A</b> (Pg. 44)	1.175"	23.25"
<b>66590</b>	Flexible rubber edge	<b>1212R</b> (Pg. 44)	1.1875"	23.25"

# HAND GREASE PUMPS

Up To  
No. 2  
NLGI

GREASE

## 540

- Variable stroke develops up to 4,000 PSI
- Delivers 0.3 oz per stroke
- 22 lb steel container with carrying handle
- Heavy-duty cast iron pump
- 6 ½' high pressure hose with 4 jaw coupler
- Spring loaded follower plate
- Container must be used with this pump and bulk filled
- Recommended for grease up to NLGI No. 3



Manual grease dispensing system includes spring loaded pump, booster control handle, follower plate, and 9' hose. Simply pump the handle until it stays in the down position indicating the hose is pressurized.

After approximately 3.2 oz of grease is dispensed, the handle will rise and indicate the hose needs to be repressurized. Features a high pressure or high flow button on the control handle.

The handle is a single shot style and includes connecting hose, swivel, and a switch for high volume or high pressure.



## 541

- Foot operated
- High pressure, portable grease pump
- Hands Free - Fatigue Free Operation
- Ideal for bulk greasing applications
- Includes Quick Lock coupler (102)
- Max Pressure: 8,700 PSI
- Up to .07 oz per stroke
- Holds up to 22.05 lbs of grease

## GS541 (Optional Assembly for 541 & 540)

- Easily load bulk grease into containers
- Helps to reduce the risk of contamination
- Grease Swipe cleans the scoop on both sides
- Helps keep hands clean



## 567

- Fits 25 to 50 lb pails
- Maximum output pressure 8,000 PSI
- Booster control handle
- Follower plate (107016)
- 9' low pressure hose
- Recommended for grease up to NLGI No. 2

## 550

- Fits 25 to 50 lb pails
- Maximum output pressure 3,500 PSI
- Delivers 1.2 oz per 28 strokes
- 4 jaw coupler
- Follower plate (107016)
- 6' high pressure hose
- Carrying handle
- Easily dispense to a grease system
- Recommended for grease up to NLGI No. 2



# BEARING PACKERS

## Portable, Bench Type, Pails and Drums

Up To  
**No. 2**  
NLGI

Recommended For Packing Bearings with a Maximum 6" Diameter

GREASE



### 331

- Portable bearing packer with grease gun
- Non-threaded top cone for fast placement of bearings
- Dust cover
- Extended base
- Gun holder (149SP)
- Lever style grease gun (419)



### 333

- Grease pump and bearing packer for 25 to 50lb pails



### 343

- Grease pump and bearing packer for 120lb drums

Model	333	343
Delivery	Variable stroke, up to 1oz per stroke	Variable stroke, up to 1oz per stroke
Follower Plate	107012	1523
Pump Construction	Zinc Plated	Zinc Plated
Head Construction	Zinc Die Cast	Zinc Die Cast
Pump Length	18"	30"
Drum Cover Diameter	12" Powder Coated	16" Powder Coated
Collar	Adjustable	Adjustable



### 625

- Bench type
- For use with hand or air operated grease gun
- Non-threaded top cone for fast placement of bearings
- Dust cover
- Mounting base

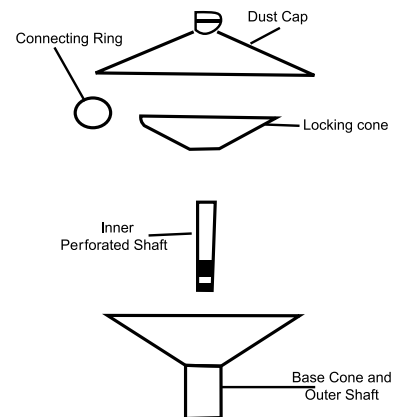



# GREASE GUN FILLER PUMPS

For Filling From Drums and Pails

## NLGI Grades

NLGI Grade	Worked Penetration After 60 Strokes At 25°C (0.1mm)	Appearance	Food Consistency Comparison
000	445-475	Fluid	Ketchup
00	400-430	Fluid	Applesauce
0	355-385	Very Soft	Brown Mustard
1	310-340	Soft	Tomato Paste
2	265-295	Moderately Soft	Peanut Butter
3	220-250	Semi-fluid	Vegetable Shortening
4	175-205	Semi-hard	Frozen Yogurt
5	130-160	Hard	Smooth Pate
6	85-115	Very Hard	Cheddar Cheese Spread

GREASE

### 327

- Fits 120lb drum
- Pump Length 30"
- Drum cover diameter 16"
- Steel edge follower plate (1523)



### 328

- Fits 25 to 50lb pails
- Pump length 18"
- Drum cover diameter 12"
- Rubber lined follower plate (107012)

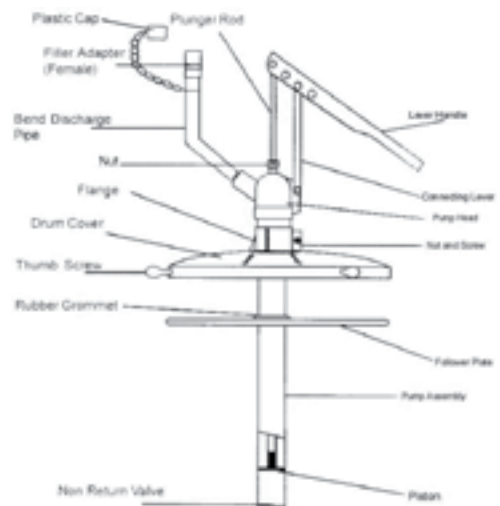

Model	327 & 328
Delivery	Variable stroke, up to 1oz per stroke
Pump Construction	Zinc Plated
Head Construction	Die-cast Aluminum
Flange Construction	Cast Aluminum
Male Loader Nipple	80SP
Female Loader Nipple	29

# GREASE GUNS

Up To  
**No.2**  
NLGI

## 19.2 Volt Cordless Grease Gun

GREASE

**BEST  
SELLER**

(912-19L)

### 912-19

- NiCad
- Includes 1 charger (91202-19)
- Includes 2 batteries (91201-19)

### 912-19L

- Lithium
- Includes 1 charger (91202-19L)
- Includes 1 battery (91201-19L)
- 5 Cells WH 27.75
- 19.2 volt NiCad to Lithium retro fit kit (912-19LK)
- Convert ALL National-Spencer 912-19 NiCad grease guns to the NEW 19.2 volt lithium grease gun
- Lithium has 30% more power than NiCad
- Kit includes: 1 battery (91201-19L) and 1 charger (91202-19L)



### 91203-19

- 12 volt car charger
- Only works with NiCad Battery

### Features For Both Models

- 19.2 volt cordless grease gun
- Recommended for grease up to NLGI No. 2 at minimum 50° F
- For delivery of grease in a variety of applications and hard to reach places
- Loading options: cartridge, suction, or bulk
- Max pressure: 8,500 PSI
- 30" whip hose with spring guard
- 1/8" NPT outlet threads
- 14 1/2 oz cartridge capacity
- Air bleeder valve
- Shoulder strap (91207-19)
- Hard plastic storage case



**Shipping lithium batteries requires additional documents.**



Do Not Mix Batteries and Chargers. Only Use NiCad batteries with NiCad Chargers and Lithium Batteries with Lithium Chargers.

## 20 Volt Lithium Cordless Grease Gun

### 912-20

### Features

- Max Pressure: 10,000 PSI
- Dispenses approximately (8) 14 oz tubes per charge
- 42" whip hose with spring guard
- Large digital display:
  - Battery level indicator
  - Amount of grease indicator
  - Amount of grease dispensed displays per each activation
  - Display flashes when no grease is being dispensed
  - 180° viewing angle
- 1 watt LED work light
- High and low volume settings
- Motor has mechanical overload protection
- Built-in floor stand
- **Lithium only**

### Includes

- **(2) 20 volt Lithium ion batteries**
- (1) AC charger
- Shoulder strap
- Hard plastic carrying case
- MAH: 2,000
- 2 year warranty



**NEW**



LCD Screen



Carrying Case



Shoulder Strap



# GREASE GUNS

## Air Operated Grease Guns



### 911

- Single Shot
- Male quick connect fitting

### 914

- Continuous Flow

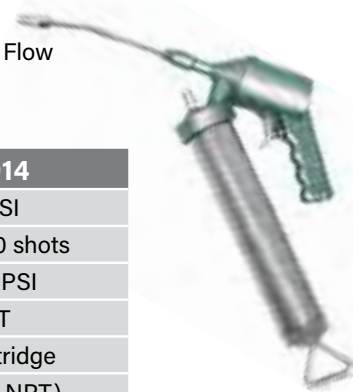

Model	911 & 914
Max Outlet Pressure	4,000 PSI
Delivery	1.30oz per 40 shots
Inlet Pressure	75 to 100 PSI
Air Inlet	1/4" NPT
Capacity	14 1/2oz cartridge
Extension	6" steel (1/8" NPT)
Loading options	Cartridge, suction, bulk
Construction	Aluminum die cast head

**GREASE**

### 173 Impact Lubrication Grease Gun



- Plunger rod produces vacuum to discharge grease
- Small tip opening for precise placement of lube
- Die cast aluminum head
- 2 threaded pockets to hold spare needle nozzles
- Delivers up to 1 oz per 95 strokes
- Manually filled (no grease cartridge is available)
- Compatible with most flush type fittings/openings
- Capacity: 3 oz (85 gms)
- Diameter: 1.5"
- Easy one hand operation
- Powder coated finish
- Includes needle nozzles with size:
  1. 0.028" (0.7 mm)
  2. 0.039" (1.0 mm)
  3. 0.055" (1.4 mm)
- Used mostly for air tool lubrication like impacts.



Slide backwards for Continuous Mode



Press button for Single Shot operation

### 915 Dual Mode Air Operated Grease Gun

#### Patented Design

- Fully automatic free outflow and single shot / grease discharge on demand in 'ONE GUN'
- Designed for outstanding durability and dependability, this 'ONE GUN' eliminates the need to have two separate guns - continuous flow and single shot.

#### Built Tough

- Heavy duty and durable Aluminum die cast head with precision honed internal bore. Head fitted with bulk loader that doubles as an air bleeder.
- Ergonomic pistol grip and acute angle design for higher balance and ease of use, especially in narrow work spaces.
- Sturdy variable trigger mechanism to dispense grease.
- Grease gun barrel in premium powder coated finish with clip mounted on the barrel for securing hose & coupler when not in use.

#### Dual Mode

- Switch between fully automatic- continuous grease flow operation and on demand/single shot operation, with the slide of an easy to use button.
- Complete with 30" (760 mm) flexible grease hose & coupler.



Specifications	
Develops	Up to 6,000 PSI
Delivers One Shot Mode	Up to 0.90 gm / shot (1.30 oz / 40 strokes)
Delivers Continuous Flow	Up to 400 gm / min (14 oz / min)
Air Operating Range	40-150 PSI (30-10 BAR)
Pressure Ratio	40:1
Air Compressor Volume	1 cfm / 0.026 cbm
Air Inlet Threads	1/4" (F)

# GREASE GUNS

## Pistol Grip

Up To  
**No. 2**  
NLGI

GREASE



**610**

- Zinc plated barrel
- 4" steel extension (59004)



**619**

- Powder coated barrel
- 4" steel extension (59004)



**613**

- Zinc plated barrel
- 12" whip hose (12R)



**620**

- Powder coated barrel
- 12" whip hose (12R)

### Features for All Models

- Ergonomic pistol grip operation
- If gun fails to pump grease, unscrew the barrel from the head assembly one turn to release any air pockets.

Model	All Models
Max Outlet Pressure	5,000 PSI
Delivery	1oz per 40 strokes
Coupler	4 jaw (27)
Capacity	14 ½oz cartridge
Threads	⅛" NPT
Loading Options	Cartridge, suction, bulk
Loading Nipple	Optional (80SP)

# GREASE GUNS

## Pistol Grip



### 609

- Adjustable stroke, for higher pressure or more volume, grease gun with 18" whip hose and coupler

Model	609
<b>Max Outlet Pressure</b>	7,000 PSI
<b>Delivery</b>	1oz per 31 strokes
<b>Capacity</b>	14 ½oz cartridge
<b>Loading options</b>	Cartridge, suction, bulk

**GREASE**

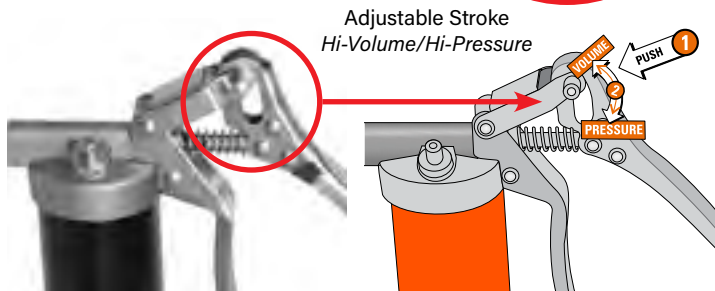

### 615

- Chrome plated barrel
- 2 grease outlets
- Rigid 4" steel extension (1/8" NPT)

Model	615
<b>Max Outlet Pressure</b>	5,000 PSI
<b>Delivery</b>	1 ½oz per 40 strokes
<b>Capacity</b>	14 ½oz cartridge
<b>Loading options</b>	Cartridge, suction, bulk

### Accessories

#### 149SP

- Grease gun holder

#### 80SP

- Loader Nipple

#### 12R

- 12" flex grease hose

#### 33

- 14 ½oz grease cartridge

# GREASE GUNS

## Lever Style

Up To  
**No. 2**  
NLGI

GREASE



### 410

- Zinc plated barrel
- 5 ½" steel extension (55)
- Rubber grip



### 413

- Zinc plated barrel
- 12" flexible whip hose (12R)
- Rubber grip



### 414

- Die cast aluminum head
- Chrome plated finish
- 5 ½" steel extension (55)
- 12" flexible whip hose (12R)



### 415

- Die cast aluminum head
- Chrome plated finish
- 5 ½" steel extension (55)



### 419

- Red powder coated finish
- 5 ½" steel extension (55)



### 420

- Red powder coated finish
- 5 ½" steel extension (55)
- 12" flexible whip hose (12R)



### 444

- Die cast aluminum head
- Powder coated finish
- 5 ½" steel extension (55)

*If gun fails to pump grease, unscrew the barrel from the head assembly one turn to release any air pockets.*

Model	All Models
Max Outlet Pressure	7,000 PSI
Delivery	1oz per 28 strokes
Coupler	4 jaw (27)
Capacity	14 ½oz cartridge
Threads	⅛" NPT
Loading Options	Cartridge, suction, bulk

# GREASE GUNS

## Premium Grease Guns

Up To  
**No. 2**  
NLGI



### HD4

- 5 1/2" steel extension (55)



### HD4A

- 12" flexible whip hose (12R)

### Features for Both Models

- Maximum pressure 10,000 PSI
- Soft rubber grip on lever handle for comfortable operation
- Heavy-duty cast iron head incorporates bulk loader nipple
- Short stroke for ease of use in confined spaces
- Delivers 1oz per 28 strokes
- Powder coated
- Holds 14 1/2oz cartridge or can be bulk loaded
- Hydraulic coupler (27)
- Loader nipple (80)
- Multiple loading options (cartridge, suction, or bulk)

**BEST  
SELLER**  
(HD4A)



GREASE

### Grease Guns with Clear Grease Tubes

A clean and easy way to determine the type of grease you are dispensing when it matters.



### 620CTB

- 12" flexible whip hose (12R)
- Maximum pressure 5,000 PSI
- Delivers 1oz per 40 strokes

Color	Model
Silver	620CTS
Purple	620CTP
Black	620CTK
Green	620CTG
Gold	620CTY
Blue	620CTB
Red	620CTR



### HD4ACTB

- 12" flexible whip hose (12R)
- Maximum pressure 10,000 PSI
- Delivers 1oz per 28 strokes

Color	Model
Silver	HD4ACTS
Purple	HD4ACTP
Black	HD4ACTK
Green	HD4ACTG
Gold	HD4ACTY
Blue	HD4ACTB
Red	HD4ACTR



### Individual Tubes

- Clear grease tubes with anodized aluminum rings
- Fits all Zee Line grease guns and many other brands.

Color	Model
Silver	NS-CTS
Purple	NS-CTP
Black	NS-CTK
Green	NS-CTG
Gold	NS-CTY
Blue	NS-CTB
Red	NS-CTR

# GREASE GUN ACCESSORIES

## Hose Assemblies

GREASE

### 12R, 18R, & 19R

- Premium quality whip hose for hand operated grease guns.
- Offers maximum flexibility and long lasting construction.
- Rubber construction - inner tubing is Polyamide with polyurethane sheathing, reinforced diagonally in high tear resistant polyester.
- 1/8" NPT plated steel fittings



**Hoses with a Max PSI rating below 5,000 PSI are intended for manual use only.**

Hoses with a Max PSI rating above 5,000 PSI can be used with Air Operated greasing equipment.



**12R-SP**



**18R-SP**

Model	Min Qty	Description	Max PSI
12R	10	12" x 13/32"	5,800 PSI
12R-1	1	12" x 13/32" In poly bag	5,800 PSI
12R-SP	1	12" x 13/32" Blister packed	5,800 PSI
13R	1	12" x 13/32" 2 wire braid	6,000 PSI
18R	10	18" x 13/32"	5,800 PSI
18R-1	1	18" x 13/32" In poly bag	5,800 PSI
18R-SP	1	18" x 13/32" Blister packed	5,800 PSI
18RR	1	18" x 13/32" 2 wire braid	6,000 PSI
19R	10	24" x 13/32"	5,800 PSI
19R-1	1	24" x 13/32" Blister packed	5,800 PSI
19R-SP	1	24" x 13/32" Skin packed	5,800 PSI
36R	10	36" x 13/32"	3,000 PSI
36R-1	1	36" x 13/32" Blister packed	3,000 PSI
36R-SP	1	36" x 13/32" Skin packed	3,000 PSI



**Flexible Position**



**Rigid Position**



### 11SP

- Flexible and rigid extension adapter
- Maximum working pressure 5,000 PSI
- Allows operator to switch from flexible to rigid extension with one hand
- Overall length 13"
- 1/8" NPT (M)



# GREASE GUN ACCESSORIES

## Grease Tools

**186**

- Hand operated grease fitting cleaner
- For unstopping clogged grease fittings
- Plated finish with steel body
- 4 jaw grease coupler (27)
- Includes 5" flexible whip hose
- Replaceable o-ring
- Skin packaged
- Grip guard

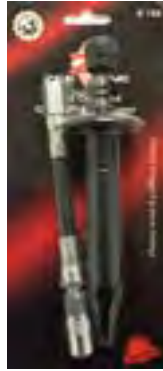

GREASE



**660**

- Quick coupler lube kit
- For efficient connection and replacement of hand operated grease gun tips
- Quick connects are included with all tools
- Attractive and durable nylon pouch

### Included Connections

- Stainless steel needle 1 1/2" long
- Lube adapter, 90° angle
- Needle nose adapter with .046 diameter tip
- Professional recessed lube adapter 3 1/4" long
- 12" hose with coupler and spring guard

**33** Sold in qty of 10

- Multi-Purpose lithium grease cartridge
- 14 oz



Grease Gun  
Not Included

**149SP** (149 sold in qty of 10)

- Grease gun holder



**159**

- Premium grease gun holder
- Extra secure
- Ideal for truck or tractor mounting
- Easy one hand operation



# GREASE COUPLERS

## Premium, Standard, and Heavy-Duty

GREASE



### 25, 27, & 28

- Sold in 10 unit increments

### 25SP, 27SP, & 28SP

- Blister packaged on a hanging card ready for display

Model	25	27	28
Max PSI	10,000 PSI	6,000 PSI	6,000 PSI
Description	Heavy-duty 3 jaw hydraulic coupler with ball check	Standard 4 jaw hydraulic coupler with ball check	Standard 3 jaw hydraulic coupler with ball check
OD	.670"	.590"	.590"



### 44

- 15,000 PSI
- Heavy-duty 3 jaw hydraulic coupler with ball check
- For air operated equipment
- OD: .662"



### 47SP

- 1,000 PSI
- Right angled hydraulic coupler
- Blister packaged



### 48

*Sold in qty of 10*

- 360° swivel coupler
- Also comes in Blister Pack (48SP)



### 52

*Sold in qty of 6*

- 7,000 PSI
- Zinc plated swivel coupler
- Locks at 45° for easy access to most grease fittings
- Also comes in Blister Pack (52SP)

### Premium Coupler

### 100



### Narrow Quick Lock Coupler

### 102



### Super Grip Quick Connect Coupler

### 104SM



Model	100	102	104SM
Max PSI	8,000 PSI	8,000 PSI	6,000 PSI
OD	.748"	.669"	.590"



### CD102



# GREASE COUPLERS

## Couplers and Adapters

Recommended for use with manual grease equipment.



- 10** Sold in qty of 10
- Steel grease pipe
  - 1/8" NPT (M) both ends
  - Approximately 15° bend
  - Also available in a skin pack (10SP)



- 31** Sold in qty of 10
- Standard button head coupler
  - For 5/8" button head fittings
  - 1/8" NPT (F) inlet
  - Also available in a skin pack (31SP)



- 22** Sold in qty of 10
- Needle point
  - 1/8" NPT x 1 1/2" long
  - Also available in skin pack (22SP)



- 32** Sold in qty of 10
- Giant button head coupler
  - For 7/8" button head fittings
  - 1/8" NPT (F) inlet
  - Also available in skin pack (32SP)



- 23** Sold in qty of 10
- Seal-off adapter
  - 1/8" NPT (F)
  - Diameter .394"
  - Length 1 1/2"
  - Also available in a skin pack (23SP)



- 55** Sold in qty of 10
- Steel grease pipe
  - 1/8" NPT (M)
  - Approximately 5 1/2" long with 15° bend
  - Also available in a skin pack (55SP)



- 24**
- Coupler connector
  - Quickly connect a non-standard coupler or tool to the existing coupler on your grease gun
  - 1/8" NPT (M)



- 65** Sold in qty of 6
- Sealed bearing packer
  - Fits grease gun coupler
  - Needle only is 1/16" x 1 1/2"
  - Also available in a skin pack (65SP)



- 29**
- Filler pump valve
  - 1/4" NPT (F) fits on grease gun filler pumps: (327) or (328)
  - Work in conjunction with (80) loader nipple



- 80** Sold in qty of 12
- Loader nipple
  - 1/8" NPT (M) for filling from gun filler pump.
  - Fits most grease guns.
  - Also available in skin pack (80SP)

GREASE

# GREASE FITTINGS

## Kits, Caps, and Feeders

GREASE



### Assorted Grease Fitting Kit - 100Pc

- 100-Pc (70 Grease Fittings & 30 Caps)
- Available in standard and metric

Model 10066 (standard)		Model 10066M (metric)	
Fitting Size	Qty	Fitting Size	Qty
1/4"-28 Straight	15	M6x1 Straight	15
1/4"-28 45°	10	M6x1 90°	10
1/4"-28 90°	10	M8x1 Straight	15
1/8"-27 Short Straight	15	M8x1 90°	5
1/8"-27 Short 45°	10	M10x1 Straight	15
1/8"-27 Short 90°	10	M10x1 90°	10
Grease Caps: Red (10), Black (10), Yellow (10)		Grease Caps: Red (10), Black (10), Yellow (10)	



### Assorted Grease Fitting Kit

- 80-Pc grease fitting assortment
- Plastic refillable box contains 6 most popular grease fittings.
- Available in standard and metric
- (66SS) only contains 40 pieces



**50SP**

- Grease fittings caps blister pack
- 10-Yellow, 10-Red



**50Y**

- Yellow grease fittings caps
- Bag of 50



**50R**

- Red grease fittings caps
- Bag of 50

Model 66 (standard)		Model 66M (metric)		Model 66SS (stainless)	
Fitting Size	Qty	Fitting Size	Qty	Fitting Size	Qty
1/4"-28 Straight	15	M6x1 Straight	20	1/4"-28 Straight	10
1/4"-28 45°	10	M6x1 90°	10	1/4"-28 45°	5
1/4"-28 90°	10	M8x1 Straight	15	1/4"-28 90°	5
1/8" NPT Straight	25	M8x1 90°	10	1/8"-27 Short Straight	10
1/8" NPT 45°	10	M10x1 Straight	15	1/8"-27 Short 45°	5
1/8" NPT 90°	10	M10x1 90°	10	1/8"-27 Short 90°	5

### Grease Feeders

- Grease feeders are used to provide single point controlled lubrication for all types of bearing housings, there by eliminating difficulties that arise from over or under greasing.

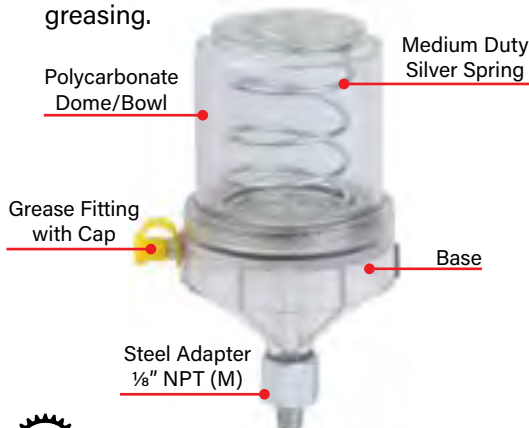

Model	47721	47722	47724	47725
Capacity	2oz	6oz	2oz	6oz
Operating Condition	Static	Static	Dynamic	Dynamic
Diameter	2.375"	3"	2.375"	3"
Height	4.625"	6"	4.625"	6"
Bowl	Polycarbonate	Polycarbonate	Polycarbonate	Polycarbonate
Base	Polycarbonate	Polycarbonate	Aluminum	Aluminum

# GREASE FITTINGS

## Standard, Button Head, Metric Fittings and Tools

GREASE

### Button Head Fittings



Sold in qty of 10

**34**

- 1/8" NPT for 5/8" Standard



Sold in qty of 10

**37**

- 1/4" NPT for 5/8" Standard



Sold in qty of 10

**38**

- 1/4" NPT for 7/8" Giant

### Metric Fittings

**59\*, 60\*, 61\***

- (59) M10x1 Straight
- (60) M6x1 Straight
- (61) M8x1 Straight



\*see chart below for specific part # and quantity

### Standard Fittings



**Straight**



**45° Angle**



**90° Angle**

Fitting			Ordering Information (See Price List for minimum order quantities.)			
#	Size	Angle/Type	Blister Pack of 5	Bag of 25	Box of 100	Box of 500
70	1/8" NPT	Straight	70SP	70G	70X	70K
78	1/8" NPT	30°	78SP	78G	78X	78K
71	1/8" NPT	45°	71SP	71G	71X	71K
79	1/8" NPT	65°	79SP	79G	79X	79K
72	1/8" NPT	90°	72SP	72G	72X	72K
82SP	3/16"	Straight/Drive type	82SP	-	-	-
62	1/4" NPT	Straight	62SP	62G	62X	62K
73	1/4"-28	Straight	73SP	73G	73X	73K
83SP	1/4"	Straight/Drive type	83SP	-	-	-
74	1/4"-28	45°	74SP	74G	74X	74K
75	1/4"-28	90°	75SP	75G	75X	75K
69	5/16"	Straight/Drive type	69SP	69G	69X	69K
59	M10x1	Straight	59SP	59G	59X	59K
60	M6x1	Straight	60SP	60G	60X	60K
61	M8x1	Straight	61SP	61G	61X	61K

Fitting #	Qty
70	2
71	1
72	1
73	2
74	1
75	1
78	1
79	1

**77SP**

- Grease fitting assortment in blister pack.



### Grease Fitting Tools

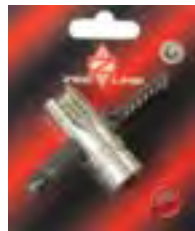

**49SP**

- Taps 1/8" NPT
- Wrench fits 7/16" and 3/8" hex
- Easy out for 1/8" NPT

(49) sold in qty of 6



**51SP**

- Taps 1/4"-28
- Wrench fits 5/16" and 3/8" hex
- Easy out for 1/4"-28

(51) sold in qty of 6

**85SP**

- "Drive Fit" grease fitting tool for straight fittings



**87SP**

- "Drive Fit" grease fitting tool for angled fittings



# ELECTRIC FUEL PUMPS

12 Volt DC & 115 Volt AC



FUEL

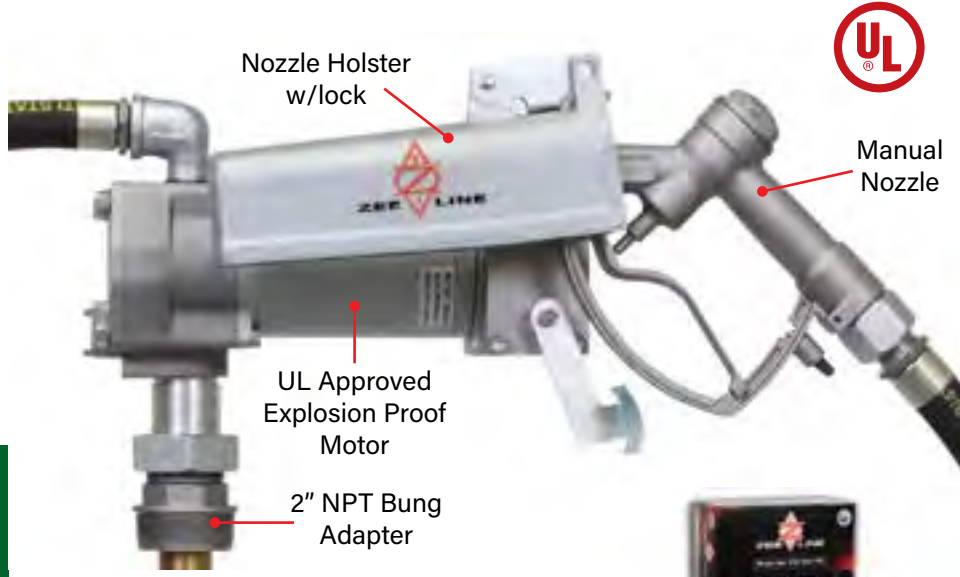

## Features for All Models

- Aluminum die cast construction
- UL approved explosion proof motor with sintered powdered gears
- NBR seals
- 34" two piece suction tube designed to fit 55 gallon drums
- Positive displacement
- Duty cycle: 30 minutes ON; 30 minutes OFF
- Removable wire mesh strainer for easy cleaning without disassembling the pump
- Wetted components are: aluminum, steel, cast iron, nylon, NBR, zinc, FKM, polypropylene, and PVC

All Zeeline Electric Fuel Pumps feature a 2-year limited warranty.

Quality products backed by premium customer service.



Model	925	930	945
Motor	12 Volt DC 1/2-HP	115 Volt AC 1/8-HP	12 Volt DC 1/2-HP
Inlet	1" NPT	1" NPT	1" NPT
Outlet	3/4" NPT	3/4" NPT	1" NPT
Hose	3/4" x 12' Anti-Static	3/4" x 12' Anti-Static	1" x 12' Anti-Static
Power Cord	15' (13ga.)	N/A	15' (13ga.)
Draw	12-amp	1.7-amp	15-amp
Nozzle	Manual	Manual	Manual
GPM	15	15	20

## Portable Fuel Dispenser

### 924

- For transferring kerosene, diesel fuel, antifreeze, and hydraulic fluid
- 12 Volt DC - light duty
- 8 to 10.5 GPM
- Cast iron construction with aluminum nozzle
- 3/4" barbed inlet and outlet
- Includes battery cables and clips
- Built in bypass valve and on/off switch
- Self-priming, positive displacement
- 13' hose for suction and discharge

*Not recommended for gasoline*



# ELECTRIC FUEL PUMPS

## 12 Volt DC & 115 Volt AC, Fuel Meters



### 926/927

- Positive displacement
- Manual nozzle holster with lock
- Duty cycle: 30 minutes ON; 30 minutes OFF
- Includes a two piece PVC suction tube

### 942

- High flow fuel transfer pump
- Thermal overload protected/internal bypass valve
- Cast iron rotor/Machined bronze vanes
- Fuel inlet strainer
- Nozzle holster with lock
- Duty cycle: 30 minutes ON; 30 minutes OFF
- U.S. and Canada UL listed; CE approved motor
- All steel telescoping suction tube

FUEL

Model	926	927	942
<b>Motor</b>	12 Volt DC ¼-HP	115 Volt AC ¼-HP	12 Volt DC ¼-HP
<b>Flow Rate</b>	13 GPM	13 GPM	20 GPM
<b>Construction</b>	Cast Iron	Cast Iron	Cast Iron
<b>Inlet</b>	1" NPT	1" NPT	1" NPT
<b>Outlet</b>	¾" NPT	¾" NPT	1" NPT
<b>Hose</b>	¾" x 12' Anti-Static	¾" x 12' Anti-Static	1" x 12' Anti-Static
<b>Power Cord</b>	15' (12ga.)	N/A	18' (12ga.)
<b>Draw</b>	20-amp	2-amp	22-amp

## Mechanical and Digital Fuel Meters

### 1514 & 1514L

- Mechanical meter with strainer

### 1512

- Electronic digital fuel meter



1514 & 1514L (Also available in 1" NPT In/Out 1514-1)	
Units of Measure	
1514	U.S. Gallon
1514L	Liters
Flow Rate	4 to 20 GPM
Accuracy	± 2%
Design Type	Nutating Disc
Housing	Aluminum
Max. Working Pressure	50 PSI
Inlet/Outlet	¾" or 1" NPT
Maximum Batch Total	999.9
Maximum Cumulative Total	999,999
Dimensions	5.5" x 4.5" x 5.5"



1512	
Units of Measure	Pints, Quarts Liters, or Gallons
Flow Rate (pump or gravity feed)	1 to 32 GPM
Accuracy	± 1%
Design Type	Turbine
Housing	Poly
Max. Working Pressure	300 PSI
Working Temp. Range	14°-122° F
Inlet/Outlet	1" NPT
Required Batteries	2 X AAA
Maximum Batch Total	9,999
Maximum Cumulative Total	99,999
Dimensions	2.75" x 3" x 2.25"

# HAND FUEL PUMPS

## Hand Diaphragm and Lever Style Pumps



### Premium Quality Pump

#### 30A1

- Manual diaphragm pump

Model	30A1
Dispenses	1 gallon per 8 strokes
Container	15-55 gallon drum
Bung Adapter	2" NPT (L30-79N)
Suction Tube	22" to 39" telescoping (L30-99N)
Hose	8' (L30-95N)
Lockable Handle	Yes
Discharge Nozzle	Yes (L30-90N)

#### Optional Accessories

- Pump brace (L30-94N)
- Repair Kit (L302193)
  - (1) Diaphragm (L30-30N) Buna N
  - (1) Seal (L30-35N) Buna N
  - (2) Reed valves (L30-52N) Buna N

#### L30-94N

- Pump brace allows for easier and more dependable pumping



FUEL

### Bio-Diesel/E85 Hand Pump

#### 202

- Rugged steel construction
- Delivers approximately 1 gal. per 9 strokes
- Yellow powder coated finish
- PTFE seals
- FKM O-ring
- Garden hose type threads on spout
- Telescoping suction tube



All Zeeline Hand Fuel Pumps feature a 2-year limited warranty.

Quality products backed by premium customer service.

### Hand Operated Transfer Pump



Pump Not Suitable for Water Based Fluids

#### 103

- Carbon steel construction
- Double check valve
- FKM o-ring
- 2 pieces (4' each) clear vinyl hose
- 2 1/4" x 11" barrel size
- Dispenses 14oz per stroke



# HAND FUEL PUMPS

## 3-Vane Cast Iron Rotary Pumps

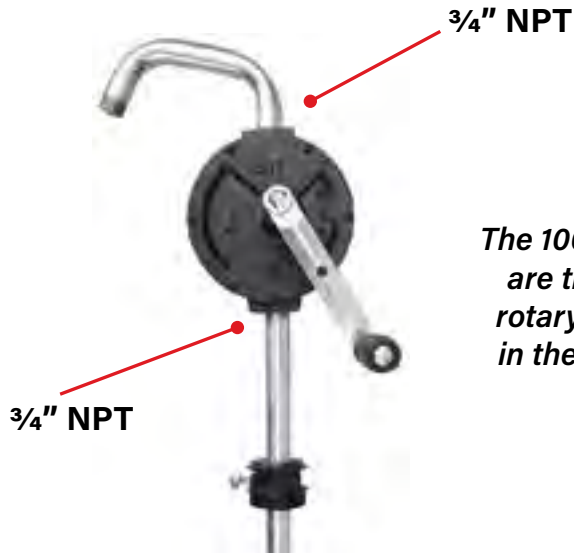

**1006**

*The 1006 Series  
are the best  
rotary pumps  
in the market*



**1006H**

- Includes 8' hose



**1006HFM**

- FM Approved
- Includes 8' hose

*Optional Accessories:*

- DG-55 drum level indicator (pg. 84)
- 169 non sparking aluminum drum wrench (pgs. 67, 90)



(DG-55)

(169)

Model	1006	1006H	1006HFM
Dispenses	1 gal. per 13 revolutions	1 gal. per 13 revolutions	1 gal. per 13 revolutions
Container	15-55 gallon drums	15-55 gallon drums	15-55 gallon drums
Construction	Cast Iron	Cast Iron	Cast Iron
Vanes & Seals	Cast Iron/Graphite	Cast Iron/Graphite	Cast Iron/Graphite
Bung Adapter	2" NPT	2" NPT	2" NPT
Suction Tube	Telescoping	Telescoping	Telescoping
Bi-directional	Yes	Yes	Yes
Hose	None	8' (L30-95N)	8' (L30-95N)
Spout	3/4" NPT	3/4" NPT	3/4" NPT
Discharge Nozzle	None	Non-Sparking w/Holder	Non-Sparking w/Holder

FUEL

# HAND FUEL PUMPS



## Two Vane Cast Iron Rotary Pumps



960



961



962



963

FUEL

### Non-Drip Attachment for Hand Pumps



#### 075NDT

- Non-Drip Tip designed to fit a broad range of hand pumps.
- 3/4" NPT (F) Fitting
- Made from PVC and Vinyl
- Can be used without the 3/4" hose barb fitting



### Retail packaging for all models.

Model	960	961	962	963
Dispenses	1 gal per 13 revolutions	1 gal per 13 revolutions	1 gal per 13 revolutions	1 gal per 13 revolutions
Container	15-55 gal drums	15-55 gal drums	15-55 gal drums	15-55 gal drums
Construction	Cast Iron	Cast Iron	Cast Iron	Cast Iron
Vanes & Seals	Cast iron/NBR	Cast iron/NBR	Cast iron/NBR	Cast iron/NBR
Bung Adapter	2" NPT	2" NPT	2" NPT	2" NPT
Suction Tube	3 pc. Rigid	3 pc. Rigid	Telescoping	Telescoping
Bi-directional	Yes	Yes	Yes	Yes
Hose	No	8' (L30-95N)	No	8' (L30-95N)
Water Deflector	WD950	WD950	WD950	WD950
Spout	3/4" NPT (M)	3/4" NPT (M)	3/4" NPT (M)	3/4" NPT (M)
Fluid Inlet	1 1/4" BSPT	1 1/4" BSPT	1 1/4" BSPT	1 1/4" BSPT
Discharge Nozzle	No	Manual (L30-90N)	No	Manual (L30-90N)
Nozzle Holster	No	Holster (53)	No	Holster (53)

# HAND FUEL PUMPS

## Two Vane Cast Iron Rotary Pumps



**1002**

*Premium  
2-Vane  
Rotary Pumps*

Pickup Tube Screen



**1003**

FUEL

Model	1002	1003
Dispenses	1 gal per 13 revolutions	1 gal per 13 revolutions
Container	15-55 gal drums	15-55 gal drums
Construction	Cast Iron	Cast Iron
Vanes & Seals	Cast iron/NBR	Cast iron/NBR
Bung Adapter	2" NPT	2" NPT
Suction Tube	3 pc. Rigid Steel w/Screen	3 pc. Rigid Steel w/Screen
Bi-directional	Yes	Yes
Hose	No	8' (L30-95N)
Water Deflector	WD950	WD950
Spout	3/4" NPT (M)	3/4" NPT (M)
Fluid Inlet	1" BSPT	1" BSPT
Discharge Nozzle	No	Manual (L30-90N)
Nozzle Holster	No	Holster (53)



### Optional Accessory:

**169**

- Non sparking drum wrench

## Fuel Filters

Recommended for regular grades of gasoline, diesel fuel, and 10% ethanol.

Fuel filters are for removing microscopic particles (up to 10 microns) of dirt, rust, sand, and scale from gravity feed tanks, hand pumps, and electric pumps.

**IMPORTANT:** These filters are not recommended for water based products, aviation fuels, race fuels or gasoline containing more than 10% ethanol.

FUEL



### NS-10

- Element has 366 square inches of filter surface for efficient filtration and optimum life
- Translucent bowl to monitor fuel quality
- 5 GPM gravity flow with 24" head
- Not for use with aviation gas



### 20

- Replacement element
- Comes with both gaskets
- Compatible with same sized filter heads

### 175

- Filter wrench for (NS-10)



Model	Description	Thread
NS-10	Fuel Filter	1" NPT
NS-10-BSP	Fuel Filter with BPT threads	1" BPT
NS-10W	Removes Water Fuel Filter	1" NPT
20	Replacement Element	-
20WB	Removes Water Element	-
BOWL	Replacement Bowl for Fuel Filters	-

### NS-30

- 10 micron filter assembly with aluminum head
- 20 GPM max flow rate
- Max working pressure 50 PSI
- Cartridge uses a 1.5-16 UNF thread
- Has three 5/16-18 BSW threads in the top of head for mounting
- Not for use with aviation gas



### NS-30AR



### NS-40



Model	Description	Threads
NS-30	Fuel Filter Assembly	1" NPT
NS-30AR	Filter Head Only	1" NPT
NS-40	Filter Element	-
NS-40WB	Removes Water Element	-

## Nozzles and Swivels

### Manual Shutoff Fuel Nozzles with Locking Triggers



**Straight Spout**

Model	Inlet	Outlet
1537	1"	1"
1538	3/4"	3/4"
1539	1"	3/4"
Retail Display 10-pack		
1537-10	1"	1"
1538-10	3/4"	3/4"
1539-10	1"	3/4"



**Curved Spout**

Model	Inlet	Outlet
1537C	1"	1"
1538C	3/4"	3/4"
1539C	1"	3/4"
Retail Display 10-pack		
1537C-10	1"	1"
1538C-10	3/4"	3/4"
1539C-10	1"	3/4"



**Straight Spout w/swivel**

Model	Inlet	Outlet
1537WS	1"	1"
1538WS	3/4"	3/4"

**Retail Display 10-pack**



FUEL

### Automatic Shutoff Fuel Nozzles with Locking Triggers



Model	Inlet	Outlet	Model	Inlet	Outlet
1541	3/4"	13/16"	1543	1"	15/16"
1542	3/4"	15/16"	15441	1"	True 1"

*Automatic nozzles won't work with gravity feed systems.*

### DEF Nozzles with Locking Triggers



**DEF-15**

- Manual shutoff
- Stainless steel spout
- FKM seals
- 3/4" O.D. spout
- 3/4" hose barb

**DEF-905**

- Automatic shutoff
- Locking trigger
- Polypropylene body
- Stainless steel nozzle
- 3/4" SS hose barb
- 2.6 - 13 GPM flow rate
- Light Weight: 1 lbs.
- 5 times lighter than all SS version
- Costs 58% less than all SS version
- Individually boxed



**DEF-906**

- Automatic shutoff
- Stainless steel spout
- FKM seals
- 3/4" O.D. spout
- 3/4" NPT (F)

*Automatic nozzles won't work with gravity feed systems. (DEF-905 & DEF-906)*

### Fuel Nozzle Accessories



**DEF-107233**

- Stainless steel
- Works with DEF-906
- 3/4" hose barb
- 3/4" NPT (M)



**Dual Plane Swivel**

Model	Inlet	Outlet
75000	3/4"	3/4"
75100	1"	1"

**NEW**



**Break Away Valve**

Model	Inlet	Outlet
075BAV	3/4"	3/4"
1BAV	1"	1"

# BATTERY OPERATED PUMP

## 19.2V Rechargeable Drum Pump



**BEST  
SELLER**



**7019**

**(7019)**

- Flow rate: 7 GPM (Pumps 106 gal. per charge @ a max of 5.3 PSI)
- Uses the same battery and charger as the (912-19 & 912-19L found on Pg. 48)
- Portable; with the option of using AC power through a separate conversion kit (7019ACK)
- Compatible with DEF and many other water based chemicals such as detergents, antifreeze, chemical insecticides, and soaps
- Also compatible with petroleum products such as diesel and kerosene
- Includes S.S. screened telescoping suction tube that extends from a minimum of 33.5" to 40"
- Includes 2" NPT bung adapter and a 2" buttress adapter for plastic drums
- Includes a 79" long corrugated P.E. hose and a polypropylene nozzle with a 3/4" S.S. spout
- Nozzle holster built into the pump body
- Lithium battery: 27.5 Wh with 5 cells per battery
- Has a 15 minute duty cycle

Pump is NOT recommended for gasoline or oil.

DEF

Improved motor seals

Model	7019L	7019
Battery Type	Lithium	NiCad
# of Batteries Included (Both include 1 Charger)	1	1
Replacement Battery	91201-19L	91201-19
Replacement Charger	91202-19L	91202-19

*Shipping lithium batteries requires additional documents.*

### Optional Accessories:

**7020**

- Bulk hose sold by the foot



**7019ACK**

- 110V AC Conversion Kit



### Included Accessories for Both Models:



70

## 115 Volt Pumping Systems



**DEF-005**



**DEF-005EC**

Model	Output	Nozzle	Hose
Container: 55 gallon		Tube Length: 40"	
DEF-005	5 GPM	DEF-906	8'
DEF-005EC	5 GPM	DEF-15	8'
DEF-027	10 GPM	DEF-906	8'
DEF-027EC	10 GPM	DEF-15	8'
Container: 275 gallon		Tube Length: 48"	
DEF-010	5 GPM	DEF-906	8'
DEF-010EC	5 GPM	DEF-15	8'
DEF-028	10 GPM	DEF-906	8'
DEF-028EC	10 GPM	DEF-15	8'
Container: 330 gallon		Tube Length: 54"	
DEF-020	5 GPM	DEF-906	15'
DEF-020EC	10 GPM	DEF-15	15'

Automatic Shut Off feature of DEF-906 will NOT work with the low flow setting of the DEF pumps listed above.

Model	Size	Connections/Discharge
08DEF750	3/4" ID Sold by the foot	Open

Warning: All DEF hose should be flushed out with DEF or De-Ionized water after assembling. All DEF hose meets ISO 22241 and NFPA 70 standards.



**DEF-504G**

- Nylon digital turbine meter
- 1" NPT Inlet/Outlet
- Flow rate: 1 to 32 GPM
- Powered by 2 AAA batteries
- 300 PSI
- (2) 3/4" barb fittings



**DEF-15**

- Manual shutoff
- Stainless steel spout
- FKM seals
- 3/4" O.D. spout
- 3/4" hose barb



**DEF-906**

- Automatic shutoff
- Not for gravity fed systems
- Stainless steel spout
- FKM seals
- 3/4" O.D. spout
- 3/4" NPT (F)

**DEF-905**

- Automatic shutoff
- Not for gravity fed systems
- Locking trigger
- Polypropylene body
- Stainless steel nozzle
- 3/4" SS hose barb
- 2.6 - 13 GPM flow rate
- Light Weight: 1 lbs.
- 5 times lighter than all SS version
- Costs 58% less than all SS version
- Individually boxed



**DEF-107233**

- 3/4" hose barb x 3/4" NPT SS swivel

## Air Pump and Hose Reel



**1035SP**

- Air operated
- 1:1 double diaphragm pump
- Flow rate 14 GPM
- 1/2" NPT inlet/outlet
- Non-stalling

**DEF-7925**

- 25' x 3/4" NPT hose reel
- 250 PSI
- Inlet: 3/4" NPT (F)
- Outlet: 3/4" NPT (M)
- Stainless steel fittings and flow path
- Steel construction
- Weight: 42lbs



## Hand and 115V / 12V Operated Systems



### Hand Operated Tote Kit

#### 10231TK

- DEF Tote mounting kit
- Pumps 1 gallon per 10 rotations
- Stays primed with DEF at all times once started

#### Kit Includes:

- 3 vane rotary pump (10231)
- 46" discharge hose with SS clamp
- 8' of DEF hose - to be cut for a pick up tube and suction hose to the pump.
- 2 buttress plugs - 1 for the suction tube and one for the breather.
- Fittings kit - includes all fittings and clamps to make connection to the tote.
- Powder coated mounting bracket with adjustable shelf - bracket bolts to the tote for stable pumping.

### 9115 115V & 9112 12V

- 9 GPM (.45 HP motor)
- 3/4" hose barb inlet/outlet (w 3/4" BSP threads)
- Diaphragm pump

#### Max Amperage:

- 115V AC (9115) - 3.5 Amps
- 12V DC (9112) - 10 Amps



### Constant Duty Pump

#### 9116 115V AC

#### Universal Pump

- Pump Type: Vane; stainless steel
- Motor: 1/2 hp 60hz
- RPM: 3400
- 15 GPM
- Amp: 3
- Dry Suction Height: 1m (3.2)
- Inlet/Outlet: 3/4"
- Power Cable: 1.6m (5-1/2")
- Duty Cycle: Continuous
- Water/Dust Protection: IP54

DEF



#### 9115SS

- SS Mounting Bracket

#### 3713

- Micro-Matic Connection

#### DEF-504G

- Digital Meter

### Electric Tote Kits

#### All Kits Include:

- 115V AC diaphragm Pump (9115)
- 4' inlet hose (08DEF750)
- 20' outlet hose (08DEF750)
- SS mounting bracket (9115SS)

Kits also available with 12V DC pump.



#### 9115TKSNM

Model	Pump	Nozzle	Meter	Tote Connection	Suction Hose
9115TKBS	9115	Plastic (DEF-15)	Not Included	DB100	5' (08DEF750)
9115TK	9115	Plastic (DEF-15)	Not Included	3713	Not Included
9115TKSN	9115	Automatic SS (DEF-906)	Not Included	3713	Not Included
9115TKSNM	9115	Automatic SS (DEF-906)	Digital (DEF-504G)	3713	Not Included
9116TKBS	9116	Plastic (DEF-15)	Not Included	DB100	Tube
9116TK	9116	Plastic (DEF-15)	Not Included	3713	Not Included
9116TKSN	9116	Automatic SS (DEF-906)	Not Included	3713	Not Included
9116TKSNM	9116	Automatic SS (DEF-906)	Digital (DEF-504G)	3713	Not Included

\* Micro-Matic Connection



## Kits for 55 Gallon Drums

### Electric Kits



**DEF55-BK**



**DEF55-A**

#### Portable Pumping System



**DEF55-A**



**9115DSS**

- SS mounting bracket for 55 gallon drums



**DEF-V750**

- Vinyl hose reinforced with wire loop

Model	Pump	Nozzle	Meter	Hose	Cart	Micro-Matic
DEF55-BK	9115	DEF-15	Not Included	DEF-V750	Not Included	Not Included
DEF55-A	9115	DEF-906	DEF-504G	08DEF750	148	5703
DEF55-AEC	9115	Automatic 905	Not Included	DEF-V750	Not Included	Not Included
DEF55-BK-CD	9116	Plastic (DEF-15)	Not Included	DEF-V750	Not Included	Not Included
DEF55-A-CD	9116	Automatic SS (DEF-906)	DEF-504G	08DEF750	148	5703

### Air Operated Pump

#### 9008

- Polypropylene construction
- Designed to fit a 55 gallon drum
- Flow rate up to 8 GPM (2 GPM with 30wt oil)
- Working pressure 30-90 PSI
- Overall pump length: 51.18"
- Includes 6' vinyl hose
- Includes plastic manual nozzle with FKM seals (DEF-15)

#### Recommended For:

- Oil (maximum 30wt)
- DEF
- Water-based chemicals and fluids

*(Kits include all necessary mounting hardware and connections.)*



#### 148G

- 4 wheel trolley for carrying 16-55 gallon drums with a hose reel tray
- See Pg. 84 for more details.



# HAND PUMPS



## Siphon, Lift, and Rotary Style

Hand equipment includes 2" NPT bung adapter. DEF plastic drums and totes have 2" buttress threads.



**BEST SELLER**  
(10211)

- 10211**
- Polypropylene Construction



- 365**
- Nylon Construction



- 387**
- Stainless Steel Construction



- 10193**
- Stainless Steel Construction

*Pumps must be flushed with deionized water or DEF, in not used daily!*

**BEST SELLER**  
(375)



- 375**
- Polypropylene Construction



- 373**
- Includes 6' hose



- 373HK**  
Kit comes with:
- 8' premium vinyl hose
  - Shut off valve
  - Buttress thread adapter

DEF



- 11219**
- Stainless Steel Construction



- 11219MM**
- (11219) with (5072) coupler



- DEF-075HK**  
Kit comes with:
- 8' premium vinyl hose
  - Shut off valve
  - Buttress thread adapter

**2.5" x 5 Buttress Threads**

One opening is slightly angled and one is straight to maximize footprint on cap to connect Fill and Dispense couplers.



- 5792**
- 6" Composite two hole IBC center cap (optimized for filling and dispensing)



- 151**
- Buttress Thread Adapter
  - Nylon
  - Converts 2" NPT to 2" buttress threads

Model	Container	Output	Seals
365	15-55 Gallon	1 gal per 8 lifts	PTFE
387	15-55 Gallon	1 gal per 8 lifts	PTFE
373	15-55 Gallon	1 pint per stroke	Acetal
375	15-55 Gallon	1 gal per 10 strokes	FKM
10193	15-55 Gallon	1 gal per 13 strokes	PTFE
10211	15-55 Gallon	1 gal per 16 revolutions	FKM
11219	15-55 Gallon	1 gal per 24 revolutions	PTFE
11219MM	15-55 Gallon	1 gal per 24 revolutions	PTFE



**3713**

- Stainless Steel Micro-Matic™ coupler with 3/4" barbed outlet



**5702**

- Composite Micro-Matic™ coupler with 3/4" barbed outlet
- For totes only



**5072**

- Threaded Micro Matic™ Coupler
- 1" NPT (M)



**DEF-601**

- Polypropylene cam lock coupler with 3/4" hose barb and EPDM seals



**5703**

- Stainless steel coupler
- For 55 GAL drums only

## Dry Break System

### DB-100

- 2" Buttress Thread
- 3/4" Hose Barb Fitting (*DB-100AR*)
- 4 piece suction tube (*DB-100T*)
  - Dimensions: 1" x 52"
- Nylon 30% glass fiber



## Non-Drip Attachment for Hand Pumps

### 075NDT

- Non-Drip Tip designed to fit a broad range of hand pumps.
- 3/4" NPT (F) Fitting
- Made from PVC and Vinyl
- Can be used without the 3/4" hose barb fitting



# SPECIALTY PUMPS

Multi-Purpose, Cordless, Portable

Compatible with, but not limited to



## 7000

- Operates on (2) "D" size alkaline batteries
- Pumps approximately 250 gallons before requiring new batteries
- Flow rate up to 2.6 GPM @ 2.5 PSI
- Includes 39.4" long hose
- Suction tube length: 15.2"
- NBR seals

### Recommended For:

- Gasoline
- Kerosene
- Diesel
- Light oils

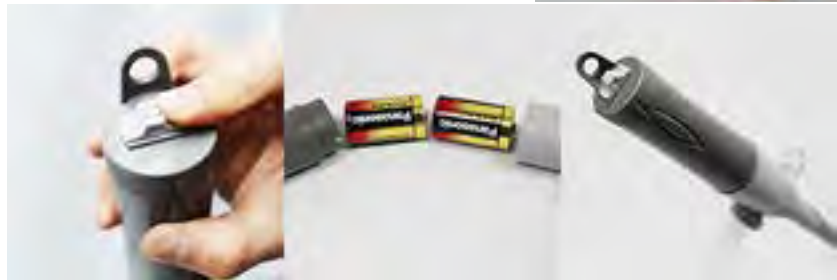

**7000** Approximately 250 gal per battery pack

**7002** Approximately 100 gal per battery pack

CHEMICAL

## 7002



- Hand Held Pump with Auto Stop
- Max delivery: 2.4 GPM
- Uses two AA batteries (not included)
- Low cost fuel dispenser with auto shut-off.
- No more over filling. Pump shuts off when liquid reaches the sensor in the nozzle.



24" Hose

Similar to (7000) but (7002) has auto stop.

### Discharge Spout with Auto Shut-Off



Compatible with, but not limited to



# AIR OPERATED PUMPS

## Multi-Purpose Transfer Pumps

Compatible  
with, but not  
limited to

ALCOHOL

ANTI-FREEZE

WIND-SHIELD  
WASHER  
FLUID

WATER  
BASED  
FLUIDS

*Ideal for car wash systems*



Pump is small enough to fit in your hand. Intended for light duty applications only.

### 1025

- Light duty double diaphragm; Air Ratio 1:1
- For transferring fluids at low pressure
- 1/4" NPT air inlet
- 3/8" NPT fluid inlet/outlet
- Up to 6 GPM
- 6.5CFM @ 100 PSI
- Polypropylene construction with santoprene seats and diaphragms, kynar check valves, and hastelloy springs
- Non-stalling, lube free

**Pump is not suitable for oil products and not recommended for use with hose reels or hoses longer than 10'**

#### Recommended Accessories

- Air line filter with nighttime drain, regulator, gauge, ball valve, and quick disconnects (*1559A-ASSY*)
- Wall mount bracket (*96*)



### 1795

- Piston style fluid pump; air ratio 1:1
- For delivery of water based fluids (wetted parts are constructed from non-corrosive materials)
- Up to 13 GPM
- 29.06 CFM @ 100 PSI

#### Included Accessories:

- 2" NPT steel bung adapter
- 24" PVC pick up tube (*1795-EXT*)
- Air line filter with nighttime drain, regulator, gauge, ball valve, and quick disconnect fittings (*1559A-ASSY*)
- 1/4" x 4' air hose
- 1/2" x 4' oil hose

#### Included Accessories:



**All Zeeline Air Operated Pumps feature a 5-year limited warranty.**

**Quality products backed by premium customer service.**

**CHEMICAL**

# HAND PUMPS

Compatible with, but not limited to



## Stainless Steel & High Flow Premium Stainless Steel Chemical Pumps



**387**

- Stainless Steel construction (316 alloy)
- Dispenses approximately 1-gal per 8 lifts
- Fits 15-55 gallon drum
- PTFE packing and seals
- Polypropylene bung adapter
- Brown Box (12)

Model	GAL	Delivers
386	5	10 oz Per Lift
387	15 - 55	20 oz Per Lift



**10110**

- Stainless Steel construction (316 alloy)
- Dispenses approximately 1-gal per 16 lifts
- Fits 15-55 gallon drum
- PTFE packing and seals
- Brown Box (20)

**151** Buttress Thread Adapter on Pg. 90



**10193**

- Stainless Steel construction
- Dispenses approximately 1-gal per 13 strokes
- Fits 15-55 gallon drum
- PTFE seal
- Brown Box (12)



**11219**

- Stainless Steel construction
- Dispenses approximately 1-gal per 24 revolutions
- 3-piece stainless steel pickup tube designed to fit 15, 30, and 55 gallon containers
- Stainless steel spring
- PTFE vanes and shaft seal
- Stainless Steel bung adapter
- Water deflector (**WD950**)
- 3/4" hose barb outlet
- Aluminum handle
- Brown Box (4)

## High Flow Gear Driven Rotary Style

Important: Not intended for gasoline or benzyl.

CHEMICAL



**1009**

- Gear driven for fast and easy transfer of light oils, diesel, alcohol, antifreeze, and windshield washer fluids
- Dispenses 1-gal per 4 revolutions (can empty a 55 gallon drum in approximately 2 minutes; 25 GPM)
- Includes a 54" polypropylene hose (**1009H**)
- Aluminum alloy construction with steel vanes and NBR seals
- 3 piece steel suction tube designed to fit 15-55 gallon drums
- 1 1/4" x 16 straight threaded spout
- Includes a 2" NPT bung adapter
- Retail Box (2)



Retail Packaging



**10250**

- Same as (**1009**) but features PPS construction, PTFE packing, and a FKM seal for upgraded chemical resistance
- Includes a 3 piece stainless steel pickup tube designed to fit 15-55 gallon drums
- Optional hose (**1009H**)
- Spout is not threaded
- Retail Box (2)



**1009H**

- 54" polypropylene hose

# HAND PUMPS

Compatible with, but not limited to

ANTI-FREEZE

METHANOL

WATER BASED FLUIDS

WIND-SHIELD WASHER FLUID

## Two and Three Vane Rotary Style

### Two Vane Rotary



1014



1014R



10240

### Features for All Two Vane Rotary Pumps:

- Dispenses 1-gal per 16 revolutions
- Lightweight and corrosion resistant
- Spout- 1" hose barb
- Outlet: 3/4" BSP
- Inlet: 1" BSP
- 1 1/4" O.D. pickup tube

### Optional Accessory

- 46" Polyethylene ribbed hose (10213)



10213



(10211)  
See chart below.

Model	Construction	Vanes	Seals	Gaskets	Recommended For (See Pg. 102 for our Chemical Resistance Chart)
1014	Polypropylene	PPS	PTFE	Polyethylene	Petroleum products, water-based chemicals, and chlorinated solvents
1014R	PPS	PPS	FKM	PTFE	Aggressive chemicals, chlorinated solvents, aromatic and aliphatic hydrocarbons
10211	Polypropylene	PPS	FKM	Polyethylene	DEF, petroleum products, water-based chemicals, and chlorinated solvents
10240	HDPE	PTFE	FKM	Polyethylene	Bleach, chlorine, and other chemicals compatible with HDPE
10255	Polypropylene	PTFE	PTFE	Polyethylene	Alcohols, petroleum products, water-based chemicals, and chlorinated solvents
10256	PPS	PTFE	PTFE	PTFE	Alcohols, chlorinated solvents, aromatic and aliphatic hydrocarbons

### Three Vane Rotary



10231

- Dispenses 1-gal per 10 revolutions
- Body & pick-up tubes PPS construction
- Lightweight and corrosion resistant
- Spout- 1" hose barb
- PTFE vanes
- PTFE seals
- Recommended for pumping aggressive chemicals including chlorinated solvents, aromatic and aliphatic hydrocarbons, etc.
- Stainless steel rotary shaft

Three vane rotary pumps provide smoother operation and a higher flow rate compared to standard two vane rotary pumps.

### Rugged Design

### Disassembled Pump



151 Buttress Thread Adapter on Pg. 90

CHEMICAL

# HAND PUMPS

Compatible with, but not limited to



## Lever & Pistol Grip Style

### Lever Style



**374**

**375**

**376/377**

### Features for All Lever Style Pumps:

- Dispenses a maximum of 12 oz. per stroke
- Lightweight and corrosion resistant
- 1" O.D. telescoping suction tube designed to fit 15-55 gallon drums
- Bung adapter will fit 1 1/4" and 2" drum openings



*Retail Packaging*

Model	Construction	Seal	Rod	Color	Recommended For (See Pg. 102 for our Chemical Resistance Chart)
374	Polypropylene	FKM & Polypropylene	Plated Steel	Blue	Lubricants, alcohol, and fuel oils
375	Polypropylene	FKM & Polypropylene	Stainless Steel	Yellow	Water-based fluids, Acid, Alkali solutions
376	PPS	FKM & Polypropylene	Stainless Steel	Black	Stronger acids, alkali, 20% nitric acid
377	PPS	FKM & PTFE	Stainless Steel	Black	Stronger acids, alkali, hexane, 20% nitric acid, toluene, toluol, trichlorethane

**151** Buttress Thread Adapter on Pg. 90

## Pistol Grip Style

**CHEMICAL**



**373**

- Dispenses 1-pint per stroke
- Polypropylene and polyethylene construction
- Telescoping suction tube designed to fit 15-55 gallon drums
- 2" bung adapter w/locking nut
- Spout- 3/4" hose barb
- Acetal seal
- Includes 1" x 6' hose

### Recommended For:

- DEF
- Water-based fluids
- Windshield washer fluid
- Mild detergents
- Oil based lubricants
- Agricultural chemicals
- And many more

**170**

- Lever lock
- Fits most lever style drum pumps
- Fits up to 1/2" locks

*Lock not included*



Drum locking ring/nut for positioning the pump outlet

*Retail Packaging*



# HAND PUMPS

Compatible with, but not limited to

ALCOHOL

ANTI-FREEZE

WATER-BASED FLUIDS

WIND-SHIELD WASHER FLUID

## Lift and Siphon Style

### Lift Style



360

363

365

### 360, 363, & 365:

- Dispenses approximately 1-gal per 8 lifts
- Designed to fit 15-55 gallon containers

Model	Bung Adapter	Construction	Seal	Rod
360	Yes	Polypropylene	FKM	Nickel Plated Steel
363	Yes	Nylon	FKM	Nickel Plated Steel
365	Yes	Nylon	PTFE	Stainless Steel

*(365) works well with Hand Sanitizers*



10044

10050

151 Buttress Thread Adapter on Pg. 90

### 10044

- Dispenses approximately 1-gal per 16 lifts

### 10050

- Dispenses approximately 1-gal per 8 lifts

### Features for (10044) & (10050):

- Designed to fit 15-55 gallon containers
- Includes 5 gallon pail adapter

#### Recommended For:

- Water-based fluids
- Light oils
- Mild acids
- Soaps
- Detergents
- Waxes
- Deodorants
- Etc.

### Siphon Style

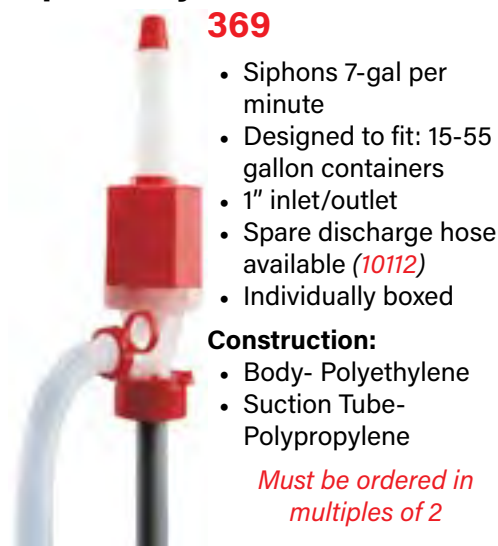

369

- Siphons 7-gal per minute
- Designed to fit: 15-55 gallon containers
- 1" inlet/outlet
- Spare discharge hose available (10112)
- Individually boxed

#### Construction:

- Body- Polyethylene
- Suction Tube- Polypropylene

*Must be ordered in multiples of 2*

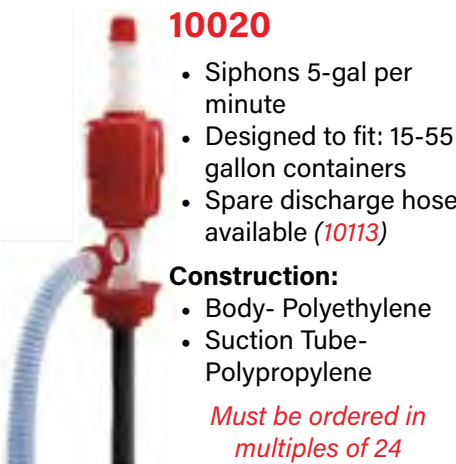

10020

- Siphons 5-gal per minute
- Designed to fit: 15-55 gallon containers
- Spare discharge hose available (10113)

#### Construction:

- Body- Polyethylene
- Suction Tube- Polypropylene

*Must be ordered in multiples of 24*

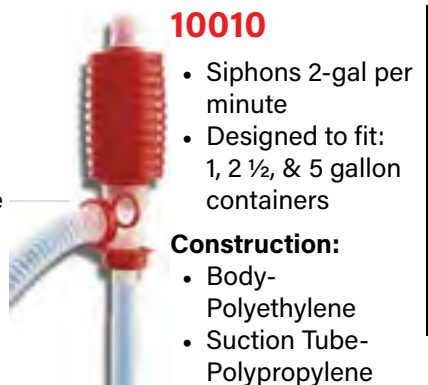

10010

- Siphons 2-gal per minute
- Designed to fit: 1, 2 1/2, & 5 gallon containers

#### Construction:

- Body- Polyethylene
- Suction Tube- Polypropylene

*Must be ordered in multiples of 120*

### 369AR

- Same as (369) but bulk packaged

*Must be ordered in multiples of 24*

Siphon pumps are ideal for transferring or dispensing harsh chemicals. Their complete polypropylene/polyethylene construction makes them compatible with a wide range of industrial fluids. Please consult our Chemical Resistance Chart on Pg. 98 for specific compatibility concerns.

CHEMICAL

# SPECIALTY PUMPS

## 115V Pumping System for 55 Gallon Drum



### EFP-005

- Ideal alternative to slow, troublesome hand pumps
- Flow rate up to 5 GPM
- Pump length: 40"
- Includes plastic nozzle (*DEF-15*)
- Includes 2" NPT bung adapter (*10217*)
- Includes 3/4" x 8' vinyl hose (*2156*)

#### Recommended For:

- Antifreeze
- Windshield washer fluid
- *Not for kerosene*

## Hand Operated Tire Sealant Pump



### 240

- Pumps tire sealant directly into tubeless tires
- Dispenses approximately 1-gal per 16 lift strokes
- Adjustable collar allows the user to control the amount of sealant dispensed per stroke by changing the stroke length
- Designed to fit 5-6 1/2 gallon pails
- Powder coated cover
- Return valve (*240-115*)
- 5' vinyl hose (*240-122*)
- Quick connect valve stem coupler (*240-127*)

# VALUE PUMPS

All Zeeline Value Pumps feature a 1-year limited warranty.

## Air Operated - For Oil, Chemicals, & DEF



### 9008

- Polypropylene construction
- Designed to fit a 55 gallon drum
- Flow rate up to 8 GPM (2 GPM with 30wt oil)
- Working pressure 30-90 PSI
- Overall pump length: 51.18"
- Includes 6' vinyl hose
- Includes plastic manual nozzle with FKM seals (*DEF-15*)



#### Recommended For:

- Oil (maximum 30wt)
- DEF
- Water-based chemicals and fluids

## Hand Operated - For Petroleum Products



### 10210

- An economical cast iron pump with steel internals for use with: kerosene, diesel fuel, low viscosity oil, etc. (Not for use with water.)
- Includes 3 piece suction tube and strainer
- Dispenses Approximately 1-gal. per 13 revolutions
- For 15, 30, and 55 gallon drums



### 10190

- An easily operated pump with die-cast zinc alloy body, ideal for high viscosity liquids such as paraffin, gear oil, etc.
- Suction tube telescopes to fit various containers.
- Includes curved spout and high angle spout.
- Dispenses approx. 1 gal. per 4 strokes
- For 15 to 55 gallon containers



### 10191G

- A Chrome-plated pump for non-water based and non-corrosive liquids, including lightweight lubricants, antifreeze, fuel oils, etc.
- Suction tube telescopes.
- Threaded for 2" or 1½" NPT bung.
- Removable spout threaded for 3/4" garden hose fitting.
- Dispenses approx. 1 gal. per 10 strokes
- For 15 to 55 gallon containers

## Hand Operated - For Mild Chemicals



### 10120

- A zinc-plated pail pump with steel and polyethylene parts for waxes, detergents and other non-corrosive liquids.
- Locking strap holds pump in place to adapt to a variety of pail openings.
- Dispenses approx. 1 gallon per 32 lift strokes
- For 5 & 6 gallon pails



### 10130

- A fast-flow zinc-plated pump for soaps, waxes and other non-corrosives.
- Removable spout threaded for ¾" garden hose fitting.
- Dispenses approximately 1-gal per 8 lifts
- For 15 to 55 gallon containers



### 10080

- An economical zinc-plated steel pump with polyethylene internal parts for mild soaps, waxes, thinners, etc.
- Dispenses approx. 1 gal. per 16 lifts
- For 15 to 55 gallon containers

## Polypropylene Tank Gauge

### Available Models:

#### TG60

- Polypropylene Tank Gauge with a maximum length of 60"

#### TG72

- Polypropylene Tank Gauge with a maximum length of 72"

- The Polypropylene Tank Gauge is ideal for measuring the remaining fluid in a tank without having to take off the bung cap and guess the depth of the fluid.
- 1.5" & 2" NPT threads



### Recommended For:

- Gasoline
- Diesel
- Alcohol
- Ether
- DEF
- And most other chemicals



Box Packaging

## Lock Out



Closed

Open



*Prevents quick coupler from making a connection while locked.*

#### LO100

- Lock Out for air supply units
- Works with 3/8" air coupler fittings
- Hole for lock is 7/16"
- Made from Aluminum
- Packaged in a bag



## Drum Level Indicator

### DG-55

- 3/4" drum level gauge.
- Conveniently check the remaining fluid level of a 55 gallon drum.
- Constructed from Polyethylene and ABS plastic.
- Can display in Liters or Gallons.

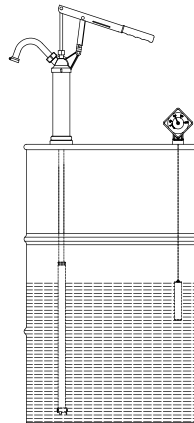

Fits the smaller 3/4" hole on drums, leaving the 2" hole free for installing pumps.



Retail Packaging

# HOSE ASSEMBLIES



## Manual Pump Hose Assemblies

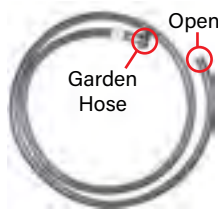

**36**

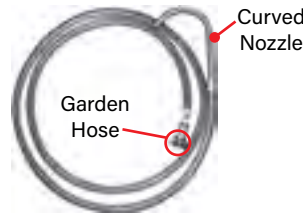

**88**



**L30-95N**

Model	Material Type	I.D.	Length	Compatible With	Inlet	Outlet
<b>36</b>	Clear vinyl	1/2"	5'	D-S, 338, 366, 381	Garden hose	Open
<b>88</b>	Clear vinyl	1/2"	8'	D-S, 338, 366, 381	Garden hose	Curved nozzle
<b>2154</b>	Clear vinyl	3/4"	4'	960, 1002	3/4" NPT (F)	Open
<b>2156</b>	Clear vinyl	3/4"	6'	960, 1002	3/4" NPT (F)	Open
<b>2158</b>	Clear vinyl	3/4"	8'	960, 1002	3/4" NPT (F)	Open
<b>2134</b>	Clear vinyl	5/8"	4'	360, 363, 365	Coupling nut	Plastic Nozzle
<b>2136</b>	Clear vinyl	5/8"	6"	360, 363, 365	Coupling nut	Plastic Nozzle
<b>L30-95N</b>	Black rubber	3/4"	8'	30A1	3/4" NPT (M)	3/4" NPT (M)
<b>2178</b>	Black rubber	3/4"	8'	960, 962, 1007	3/4" NPT (F)	Aluminum Nozzle
<b>10039-1P</b>	Nitrite/PVC blend	3/4"	12'	926, 927	3/4" NPT (M)	3/4" NPT (M)

## Hose Assemblies for Air Operated Equipment

### Low Pressure

- Low pressure hose assemblies are ideal for air and water reels
- 1/2" I.D.
- Maximum working pressure 250-lbs.
- Minimum burst pressure 1,000-lbs.
- Inlet/Outlet: 1/2" NPT (M)

Model	Length
2300	1'
2320	20'
2325	25'
2330	30'
2340	40'
2350	50'

### Medium Pressure

- Medium pressure hose assemblies are ideal for air operated oil pumps and hose reels
- 1/2" I.D. fiber braid
- Maximum working pressure 1,125-lbs.
- Minimum burst pressure 4,500-lbs.
- Inlet/Outlet: 1/2" NPT (M)

Model	Length
2205	5'
2210	10'
2215	15'
2220	20'
2225	25'
2250	50'

### High Pressure

- High pressure hose assemblies are ideal for air operated grease pumps and hose reels
- 1/4" I.D. wire braid
- Maximum working pressure 5,000-lbs.
- Minimum burst pressure 20,000-lbs.
- Inlet/Outlet: 1/4" NPT (M)

Model	Length
1802	2'
1804	4'
1806	6'
1810	10'
1812	12'
1816	16'
1820	20'
1825	25'
1850	50'

### DEF Hose

**Warning:** All DEF pumps, nozzles, and hoses should be flushed with DEF or de-ionized water after assembling. All DEF hoses meet ISO 22241 and NFPA 70 standards.



**DEF-V750**

### DEF Hose (sold by the foot)

Model	I.D.	Inlet	Outlet	Material
08DEF750	3/4"	Open	Open	Black Rubber
DEF-V750	3/4"	Open	Open	Clear Vinyl

ACCESSORIES

# HOSE REELS

## Heavy-Duty Reels



**BEST SELLER**  
(1444R)



**1444R**

**1444HD**

**1481NS**

### Features for All Heavy-Duty Reels:

- Perfect for stationary and mobile truck mounting
- Steel construction with heavy-duty base
- Dual arm support
- 3-position guide for ceiling, wall, or bench mounting
- Adjustable hose stop
- Drum support bushing with self-lubricating material
- Durable powder-coated finish

All Zeeline Hose Reels feature a 2-year limited warranty.

Quality products backed by premium customer service.

Model	Hose W x L	Max. PSI	Inlet	Outlet	Dimensions
<b>Grease - High Pressure</b>					
1440R	1/4" x 52'	5,000 PSI	1/4" NPT (F)	1/4" NPT (M)	A
1474R	1/4" x 39'	5,000 PSI	1/4" NPT (F)	1/4" NPT (M)	A
1440HD	1/4" x 50'	5,000 PSI	1/4" NPT (F)	1/4" NPT (M)	E
<b>Oil, ATF &amp; Gear Lube - Medium Pressure</b>					
1444R	1/2" x 49'	2,500 PSI	1/2" NPT (F)	1/2" NPT (M)	B
1475R	1/2" x 32'	2,500 PSI	1/2" NPT (F)	1/2" NPT (M)	A
1444HD	1/2" x 50'	2,500 PSI	1/2" NPT (F)	1/2" NPT (M)	E
<b>Air &amp; Water - Low Pressure (Also compatible with anti-freeze &amp; windshield washer fluid.)</b>					
1448R	1/2" x 49'	300 PSI	1/2" NPT (F)	1/2" NPT (M)	B
1456R	3/8" x 39'	300 PSI	3/8" NPT (F)	3/8" NPT (M)	A
1458R	3/8" x 59'	300 PSI	3/8" NPT (F)	3/8" NPT (M)	A
<b>Gasoline &amp; Diesel - Low Pressure</b>					
1481NS	3/4" x 50'	50 PSI	3/4" NPT (F)	3/4" NPT (M)	C
1482NS	1" x 50'	50 PSI	1" NPT (F)	1" NPT (M)	D

Dimensions	Bolt Pattern	Height	Width
A	5.500" x 7.700"	16.100"	7.300"
B	5.500" x 7.700"	18.100"	7.300"
C	6.000" x 10.000"	25.375"	10.125"
D	7.875" x 10.500"	25.375"	15.250"
E	3.858" x 7.835"	20.748"	7.20"

Optional accessory **URM100** Universal Ceiling mount (see pg. 90)

## Standard Duty & Specialty Reels

### Low Pressure Air & Water Hose Reels



#### Features for All Standard Duty Air & Water Reels:

- Stamped steel construction with reinforced ribs for increased strength
- The industrial-grade drive spring is protected from the environment
- Stainless steel torsion spring is used on the latch to insure maximum life
- Steel components are individually powder coated and teamed with composite materials, which virtually eliminates corrosion
- Versatile mounting- the guide arm can be adjusted to seven convenient locations
- Composite spool and steel components make the reel strong yet lighter

Model	Hose W x L	Max. PSI	Inlet	Outlet	Dimensions
1496NS	1/4" x 25'	300 PSI	3/8" NPT (F)	1/4" NPT (M)	A
1497NS	3/8" x 25'	300 PSI	3/8" NPT (F)	1/4" NPT (M)	A
1458NS	3/8" x 50'	300 PSI	1/2" NPT (F)	1/2" NPT (M)	B

Optional accessory **URM100**  
Universal Ceiling mount  
(see pg. 90)

Dimensions	Bolt Pattern	Height	Width
<b>A</b>	2.250" x 6.000"	17.875"	5.750"
<b>B</b>	2.250" x 6.000"	17.875"	6.250"

### Portable Closed Reel for Air & Water

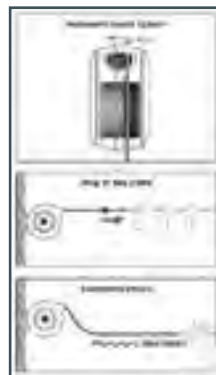

#### 1459NS

- 3/8" x 50' Reel with Advanced Auto-Stop
- No ratcheting sound
- Working Pressure: 300psi
- Inlet/Outlet: 3/8"
- Hose I.D.: 3/8"
- Hose Length: 50'
- Hose Material: Hybrid Polymer



Compatible With:



### DEF Hose Reel



#### DEF-7925

- 25' x 3/4" NPT hose
- Maximum pressure 250 PSI
- Stainless steel fittings and flow path
- Steel construction
- Weight: 42lbs.

Bolt Pattern: 7.8125" x 3.875"

*Other sizes available upon request.*

# DRUM EQUIPMENT

## Dollies, Trolleys & Carts



### 145

- Hand truck for 100-120lbs. drums
- Specially designed with a clamping feature that securely holds a 16 gallon/120lbs. drum.
- 5" solid rubber wheels
- 6" x 14" toe plate
- Height: 40"
- Width: 17 1/2"

### 150

- 3 wheel drum cart for 55 gallon/400lbs. drums
- Only 1 3/8" clearance from the ground allows for easy loading of drums and easier handling



### 147

- Adjustable trolley for carrying 16 gallon/120lbs. drums
- Ideal for creating portable grease or oil dispensing systems (pictured to the right)
- Drum top hook
- Hose hook
- Meter hook
- Self lubricating plastic and rubber wheels



*Drum, meter, and pump are not included.*

### 148/148G

- 4 wheel trolley for carrying 16-55 gallon drums with a hose reel tray
- Tough and durable powder coat finish with non-marking wheels and casters
- Total weight capacity: 539lbs
  - Drum shelf: 485lbs
  - Reel shelf: 55lbs
- Ideal for creating portable dispensing systems when combined with a pump, hose reel, and oil control handle or meter

Cup for secure holding of pump inlet & collecting dripping oil



### 148G



### 148

DESCRIPTION	148	148G
Up to 55 Gallons	Y	Y
Locking Caster(s)	1	2
Removable Handle		Y
Tilt Drum with Handle		Y
Handle with Drum Wrench		Y
Drum Clamp	Y	Y
Wheel Size	8"	6"
Caster Size	6"	4"
Reel Mounting Holes	Y	Y
Tray Size	25 5/8" x 24"	26" x 22"
Deck Height	4 1/4"	3 1/4"



# DRUM EQUIPMENT



## Dollies & Cradles



**105**



**120**



**130-S**



**138-S**



**140-S**



**140-SOR**

Model	Caster Material	Diameter (Min - Max)	Maximum Load
<b>Designed for 5-6 ½ Gallon Pails</b>			
105	Phenolic	10" - 11 5/8"	200lbs.
105-S	Steel	10" - 11 5/8"	200lbs.
<b>Designed for 15-16 Gallon Drums</b>			
120	Phenolic	13 ½" - 14 ¼"	200lbs.
120-S	Steel	13 ½" - 14 ¼"	200lbs.
<b>Designed for 30 Gallon Drums</b>			
130-S	Steel	Max - 18"	300lbs.
<b>Designed for 55 Gallon Drums</b>			
138-S	Phenolic	Max - 23"	450lbs.
140-S	Steel	Max - 23"	450lbs.
140-SOR	Steel	Max - 23"	450lbs.



**135**

- Drum cradle with axle and wheels

**137**

- Drum cradle **without** axle and wheels



**135WC**

- Drum cradle with axle, wheels, and casters

Model	135	135WC	137
<b>Tips &amp; Rotates</b>	Yes	Yes	Yes
<b>Stores</b>	55 gallon drum	55 gallon drum	55 gallon drum
<b>Self Storing Lever Bar</b>	Yes	Yes	Yes
<b>Capacity</b>	600lbs.	600lbs.	600lbs.
<b>Axle &amp; Wheels</b>	Yes	Yes	No
<b>Casters</b>	No	Yes	No

## Drum Tools and Accessories



**167**

- Universal spoke drum wrench
- Rugged, all steel construction
- Powder coated to protect against rust
- Tipped with the 4 most common drum wrench heads
- Can open 3/4" to 2" openings
- Convenient 12" x 12" x 1/2" size

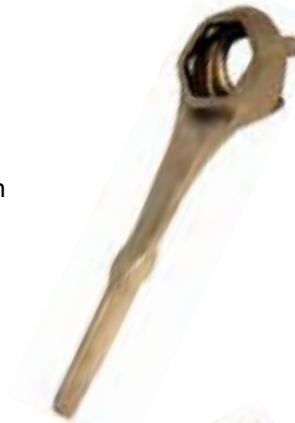

**169**

- Aluminum drum wrench
- Non-sparking
- Opens 3/4" slotted bung
- Opens 2" cross bar bung



**10265**

- Bronze alloy drum wrench
- Non-sparking
- Offset handle



**10266**

- Bronze alloy drum wrench
- Non-sparking
- Built-in 1 1/4" faucet wrench



**10267**

- Iron alloy universal drum wrench
- Fits all drum plugs and bung nuts
- Will not bend or chip under normal use
- Angled handle



**830**

- Brass horizontal drum vent
- 2" NPT



**151**

- Buttress thread adapter
- Nylon construction
- Converts 2" buttress thread to 2" NPT
- Required to mount pumps to most plastic drums

### Universal Ceiling Mount

**URM100**

- Universal ceiling mount for all hose reels.
- Ceiling mount clamps in place. No drilling required.
- Will mount to most 6"- 8" wall or ceiling I-beams.
- Includes safety cable.



Reel not included.



Side View

# DRUM EQUIPMENT



## Gate Valves, Barrel Faucets & Accessories

Compatible With:



### 3/4" Bung Faucets



63



Sold in  
qty of 12

68



81



82SS

### 1" Bung Faucet



57

### 2" Bung Faucets



64



67



89

Model	Construction	Manual/Automatic	Lockable
<b>Designed to Fit 3/4" NPT Bung Openings</b>			
63	Cast Iron	Manual	Non-Lockable
68	Polyethylene	Manual	Lockable
81	Die-Cast metal	Automatic (self closing)	Lockable
82 SS	304 Stainless Steel	Automatic (self closing)	Lockable (w/customer lock)
<b>Designed to Fit 1" NPT Bung Openings</b>			
57	Cast Iron	Manual	Non-Lockable
<b>Designed to Fit 2" Bung Openings</b>			
64	Cast Iron	Manual	Non-Lockable
67	Polyethylene	Manual	Lockable
89	Aluminum	Automatic (self closing)	Non-Lockable



5001

- Vented fill cap
- Lockable
- 2" NPT

67SG

- Level indicator that attaches to (67) bung faucet
- Works great for 55-gal drum on a cradle so you always know how much fluid is in your drum

Bung faucet  
sold separately.



Zeeline Drum Equipment features a 2-year limited warranty.

Quality products backed by premium customer service.

## Spill Containment Pallets

### 2 Drum Pallets



Our Spill Containment Pallets are made from a highly durable and chemical resistant high density polyethylene (HDPE). Each pallet comes with a black removable grate, making clean up fast and easy.

Spill Containment Pallets are ideal for safely storing chemicals that are hazardous or harmful to people and the environment. In some states, they are required by law, to safely store dangerous chemicals.

#### 782

- Will comfortably hold up to (2) 55 gallon drums
- Spill capacity: 30 gallons
- Load capacity: 4,000lbs.
- Dimensions: W- 26.25" L- 51.5" H- 6.5"



#### 782D

- Will comfortably hold up to (2) 55 gallon drums
- Spill capacity: 66 gallons
- Load capacity: 4,000lbs.
- Dimensions: W- 26.25" L- 51.5" H- 13.75"

### 4 Drum Pallets

#### 784

- Will comfortably hold up to (4) 55 gallon drums
- Spill capacity: 66 gallons
- Load capacity: 8,000lbs.
- Dimensions: W- 51.5" L- 51.5" H- 8"

*This item ships freight only.*



Spill Containment Pallets are available in other sizes upon request.

### Low Profile Drum Ramp

#### 783

- Designed to ease the loading of heavy drum onto spill containment pallets
- Load capacity: 1,500lbs.
- Dimensions:  
W- 32" L- 45.5" H- 8"
- This product is not compatible with (782D)



# AIR SENTRY BREATHERS



Air Sentry® Breathers are a unique, patented air filter and vapor removal system. They replace the standard breather or vent cap on all types of industrial equipment, storage tanks, and transformers. They prevent destructive contaminants from entering fluid reservoirs and tanks as air is breathed in and out due to thermal expansion or fluid level changes. Fluid contamination is one of the primary causes of component wear and lubricant failure in industrial equipment. Models are available to meet the requirements of most industrial applications

## Air Sentry Contamination Control Breathers:

- Ideal solution for fluid contamination problems
- Blocks corrosive water vapor
- Filters damaging particles
- Reduces other contaminants
- Protects expensive equipment
- Disposable- replace when desiccant color changes from gold to green



D-Series Breathers				
Model	Height	Diameter	Mounting Connection	Max. Adsorption Capacity
D-100	3 1/2"	5"	1" slip fit	Not Available
D-101	5"	5"	1" slip fit	8.6 fl oz
D-154	5"	5"	1" NPT (M)	8.6 fl oz
D-102	8"	5"	1" slip fit	16.56 fl oz
D-108	10"	5"	2" NPT (M)	21.47 fl oz

### D-Series Air Sentry Breathers:

The D-Series breathers feature numerous models in a variety of sizes, designed to satisfy the requirements of most stationary fluid management applications. The breathers provide application flexibility by using 100% silica gel for moisture adsorption or 100% activated carbon for fume and odor control, or both when necessary. All D-Series models feature 2-micron solid particle filtration and have a max airflow rating of 20 cfm. They also have a max reservoir fluid flow rate of 150 GPM.

The D-Series is constructed of industrial grade raw materials, tested to ensure a wide range of chemical compatibilities, and features high impact resistant ABS top and bottom caps.

**Typical Applications:** storage tanks, fluid reservoirs, transformers, pumps, and gearboxes.

Z-Series Breathers				
Model	Height	Diameter	Mounting Connection	Max. Adsorption Capacity
Z-131	2"	2"	1/2" NPT (F)	0.49 fl oz
Z-132	3 1/4"	2"	1/2" NPT (F)	0.92 fl oz
Z-133	2"	3 1/4"	1/2" NPT (F)	1.84 fl oz
Z-134	3 1/4"	3 1/4"	1/2" NPT (F)	3.06 fl oz

### Z-Series Air Sentry Breathers:

Air Sentry® Z-Series breathers are designed for applications where space is limited or air flow requirements are below 5 cfm. The Z-Series is typically used on gearboxes and low fluid volume applications where mounting space is limited or where a larger breather won't fit without remote mounting. All Z-series breathers have a max airflow rating of 5 cfm. They also have a max reservoir fluid flow rate of 37 GPM.

**Typical Applications:** gearboxes, drums, totes, and small oil containers.

Air Sentry Breather Adapters			
Model	Type	Breather Connection	Reservoir Connection
A-101	Flange	1" slip fit	customer drilled holes
A-102	Threaded	1" slip fit	1" NPT (M)
A-103	Threaded	1" slip fit	3/4" NPT (M)
A-104	Bayonet	1" slip fit	bayonet push & turn connection

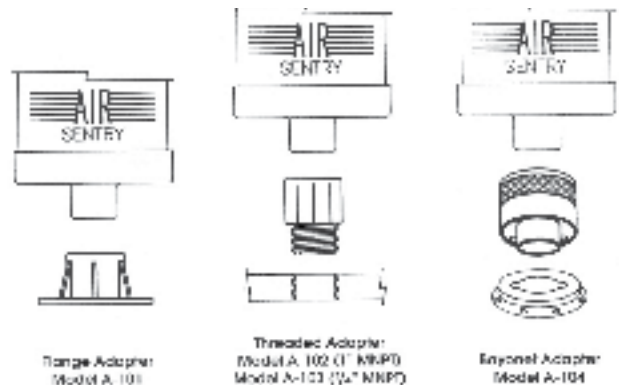

#### Flange Adapter:

Used with reservoirs where the tank wall is not thick enough for tapping threads.

#### Threaded Adapter:

Used with reservoirs where the tank wall is thick enough for a tapped hole.

#### Bayonet Adapter:

Replaces the standard breather cap on a hydraulic reservoir.

# FUNNELS



## Drum Funnel (With 2" NPT (M) threaded spout.)



- 769**
- Polyethylene construction
  - Deep 3 quart capacity



- 798**
- Heavy-duty plastic construction with hinged cover
  - 4 quart capacity
  - With screen



- 799**
- E-Z Smart Funnel
  - Funnel design protects against over filling the drum
  - 2 gallon capacity
  - No screen

## Multi-Purpose & Disposable Funnel

### Features For (759) & (761)

- Heavy-duty polyethylene
- Anti-splash rim with lid
- Screen included
- 1" O.D. Outlet

- 759** Sold in qty of 2
- 8" funnel diameter
  - Flexible spout: W- 1/2" L- 7"
  - 1.75 quart capacity

- 761** Sold in qty of 4
- 9" funnel diameter
  - Flexible spout: W- 7/8" L- 9"
  - 3 quart capacity



- 764**
- Heavy-duty polyethylene
  - Funnel opening: 10" x 7"
  - 1 1/8" O.D. outlet
  - With screen



- 770** Sold in qty of 12
- Deluxe plastic funnel
  - Wide neck for rapid filling
  - 11" flexible outlet, convenient for hard to reach places
  - 0.625" O.D. Outlet
  - No screen

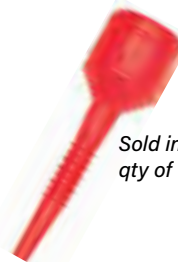

- 775** Sold in qty of 12
- King Size plastic funnel
  - One piece construction
  - Funnel diameter: 4 1/2"
  - 17" long with 5/8" outlet
  - 0.625" O.D. Outlet
  - No screen



- 790**
- Disposable paper funnels
  - 32oz
  - Sold in packs of 36

- 791**
- Disposable paper funnels
  - 8oz
  - Sold in packs of 36



## ACCESSORIES Universal Oil Drain Funnel & Accessories



- 699J**
- Replacement funnel for portable oil drains
  - Polyethylene construction
  - Fit 1 1/2" - 1 7/8" I.D. tubes
  - Fits models: 309, 316, and 318 (see Pg. 36)



- 776**
- Extension for (699J)
  - Increases funnel capture area
  - Dimensions: W- 24" L- 24"



- 778**
- Transmission funnel
  - Fits on top of (699J)
  - Increases funnel capture area
  - Dimensions: W- 24" L- 37"

# FUNNELS



## Galvanized Funnels



Sold in  
qty of 12

**86**



**701**



**703**



**705**



**707**

Model	Capacity	Spout	Screen	Outlet I.D.	Dimensions
<b>86</b>	1 quart	14" flexible	50 mesh brass	7/16"	6" diameter
<b>701</b>	1 quart	Straight	Included	1/2"	6 1/4" diameter x 8" deep
<b>703</b>	8 quart	Ribbed to fit openings	Included	1"	9 1/2" diameter x 6" deep
<b>705</b>	6 quart	Straight	50 mesh brass	1"	10" diameter
<b>707</b>	9 quart	Center	Included	1"	12" diameter x 12" deep

## Drain Pans & Drip Pan



**721**

- Galvanized utility drain pan
- 3 1/2 gallon capacity
- 15 1/2" diameter x 3 1/2" deep

**774**

- Cover for (772) drain funnel



**772**

- Designed to sit on top of a 55 gallon drum and permit drainage into the drum
- Ideal for oil cans and drain pans
- Made with durable polyethylene and will not rust



**765**

- Plastic drain pan and parts cleaner
- 13" diameter x 4" deep



**766**

- Plastic drain pan w/spout and cap
- 4 1/2 gallon capacity
- 22.91" x 18.58" x 6.14" deep



**785**

- Drip pan
- Fits any 2" NPT opening
- Fits pumps with 2" NPT bung
- Strains and returns overflow back to the drum

## Plastic Measures



(757 & 760 sold in qty of 2)

## Plastic Measures w/Flexible Spout

- Marked in quarts and liters
- Includes threaded lid
- Includes thread on outlet cap (SPOUT/CAP)
- HDPE container with polyethylene spouts and caps
- (757-W also available in translucent white)

Model	Capacity	Replacement Parts	
		Lid	Spout
731	4 quarts	731LC	LARGE CAP
732	8 quarts	732LC	LARGE CAP
751	1 quart	752G	SPOUT/751/753
753	2 quarts	754G	SPOUT/751/753
755	3 quarts	754G	SPOUT/751/753
757	5 quarts	758G	SPOUT/757
760	6 quarts	758G	SPOUT/757

(757AR & 761AR sold in qty of 15)



## Features For (731) & (732):

- Marked in liters and quarts
- Includes a threaded lid and outlet cap

**731** Sold in qty of 2

**732** Sold in qty of 2

- 4 Liter / 4 Quart

- 8 Liter / 8 Quart

## Pressurized Steel Sprayer



**1000R**

- Red powder coated finish
- 32oz capacity
- Metal construction
- Brass nozzle
- Ideal for bulk application of cleaners, degreasers, penetrating oils, solvents, and lubricants

## Battery Filler



**737**

Sold in qty of 2

- Heavy-duty polyethylene
- Automatic shutoff
- Non-drip tip
- Safe to use with battery acid
- 1.8 quart capacity (2 liters)

## Pistol Action Oilers

Model	Container Size
93	6oz
94	1 pint
95	10oz
97	1 quart

## Features For All Pistol Action Oilers:

- Include a 6" rigid steel stem and 6" flexible spout
- Deep-drawn seamless body
- Attractive red paint finish



**93**

**94, 95, 97**



## Light Reels (All Light Reels are U.L. Listed.)



**913**

- Standard cord reel
- 20' cord length; SVT type
- 1 $\frac{1}{3}$  gauge
- Rating: 7A 125V
- Maximum 75 watt bulb  
*(not included)*



**916**

- Fluorescent light cord reel
- 40' cord; SJT type
- 1 $\frac{1}{2}$  90 gauge
- Efficient 15 watt bulb
- Rating: 7A 125V



**918**

- Standard cord reel
- 50' cord; SJT type
- 1 $\frac{1}{2}$  gauge
- Rating: 7A 125V
- Maximum 75 watt bulb  
*(not included)*

## Heavy-Duty Cord & Light Reel



**1476NS**

- Powder coated steel construction
- Wall, ceiling or bench mount
- 45' cord; 1 $\frac{1}{2}$  gauge
- Rating: 15A 125V



**1477NS**

- Powder coated steel construction
- Wall, ceiling or bench mount
- 50' cord; 1 $\frac{1}{3}$  gauge
- Rating: 10A 125V

**Dimensions for Both:** Bolt Pattern- 2.500" x 8.000" Height- 13.250" Width- 9.375"

## Static Reels



**1470NS**



**1472NS**

## Features For (1470NS) & (1472NS):

- 50 amp grounding cable
- 3/32" diameter vinyl coated galvanized steel cable
- Retracting static ground cable
- Heavy-duty construction
- 1" solid steel center shaft
- Adjustable cable stop
- Spring rewind with latching device

**1470NS**

- Multi-position arm guide
- 100' cable

**1472NS**

- 50' enclosed cable



### 1559A-ASSY

- Includes: 40 micron air line filter with nighttime drain, regulator, gauge, ball valve, and quick disconnect fittings
- Inlet/Outlet: 1/4" NPT (F)



### 1559A2-ASSY

- Same as (1559A-ASSY) but also includes:
- 12" hose (2001)
  - Mounting bracket (BRKT1578)
  - 3/8" x 1/4" bushing (1167)
  - 1" x 1/4" hex nipple (1183)



### 1573A

- Heavy-duty air treatment unit provides moisture free air with a touch of oil for lubrication
- Handles 18 CFM with 100 PSI inlet pressure
- Includes: 40 micron filter, gauge, regulator, and oiler
- Inlet/Outlet: 1/4" NPT (F)



### 1574

- Combo unit for high air flow
- Includes: regulator, gauge, oiler, filter, and manual water drain
- Also includes a protective metal covering for all bowls
- Inlet/Outlet: 3/8" NPT (F)



### 1558A

- High flow 40 micron air line filter with nighttime drain
- Flow rate: 60 CFM with 90-120 PSI inlet pressure
- Max. Pressure: 150 PSI
- Inlet/Outlet: 1/4" NPT (F)



### 1559A

- Mini 40 micron air line filter with automatic drain
- Die cast body with (2) ports
- Max. Pressure: 150 PSI
- Inlet/Outlet: 1/4" NPT (F)



### 1578

- Mini air line filter with nighttime drain
- Die cast body with 2 ports
- Includes: filter, gauge, and regulator
- Max. Pressure: 150 PSI
- Inlet/Outlet: 1/4" NPT (F)



### 1550

- 1/4" Port size
- Flow rate: 48 CFM
- 5.31" high
- 1.57" wide
- Die cast Aluminum head
- Polycarbonate bowl w/ bowl guard
- Head is fitted w/oil drop indicator, oil drop controller, and oil filling plug
- Air lubricators are used to feed lubricants to pneumatic equipment
- Wetted components: aluminum, bronze, steel, acetal, polycarbonate, stainless steel, and nitrile



### 1554

- Mini air regulator with (4) ports: (2) 1/4" NPT, (2) 1/8" NPT, (with 1 plug)
- Air pressure range: 0-200 PSI



### 1556BV

- Brass ball valve
- 1/4" NPT (M); 1/4" NPT (F)



### 1561

- Dial air gauge with 2" face
- Center back connection: 1/8" NPT (M)
- Air pressure range: 0-200 PSI



### 1561G

- Digital air pressure gauge
- Center back connection: 1/8" NPT (M)
- Air pressure range: 0-200 PSI
- Digital readout will display in the unit of the user's choice: PSI, BAR, MpA, or Kg/Cm<sup>2</sup>



### 1565L

### Quick Connectors:

- **1565L** (current style)
- Zinc plated air coupler: 1/4" NPT

### 1565

- Replacement coupler for Zeeline equipment purchased prior to 2014



### 1570L

### Air Nipples:

- **1570L** (current style)
- 1/4" NPT (M)

### 1570

- Replacement nipple for Zeeline equipment purchased prior to 2014

## BK-100

- Quick change blade operation (no tools required)
- Conveniently accessible storage compartment that can hold up to 6 spare blades (included)
- No hassle 2-year limited warranty
- Replacement blades available (BK-100-B)

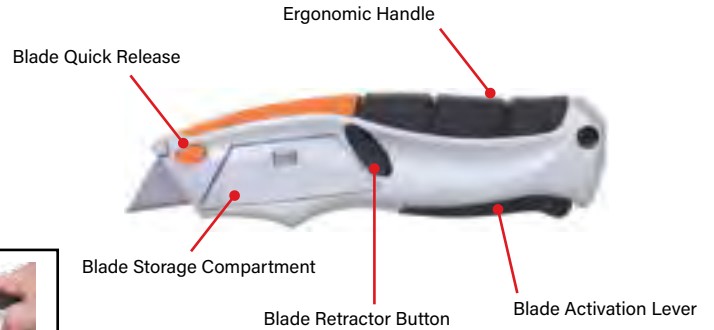

## 1518

- Digital Tire Gauge
- Back-lit LCD display
- Rugged design for durability
- 24" flexible hose with dual truck chuck
- Additional car chuck included (1566)
- Maximum pressure 300 PSI
- Uses AAA batteries



## 1566

- Locking Air chuck
- ¼" NPT (F)

- Can add air with trigger or let air out with the push button.
- Also comes with a rubber protection shroud.
- Battery operated display.

## Air Tools



## 1562

- Chrome plated, heavy-duty, and lightweight safety blow gun
- Maximum pressure: 30 PSI
- ¼" NPT (F)



## 1563

- Air chuck
- ¼" NPT (F)



## 1564

- Engine clean gun
- For use with solvents or detergents
- Blasts off dirt and grime by siphoning solvent and mixing with high air pressure



## 1567

- Tire inflating air chuck
- Gauge and 12" hose included
- Gauge reads 10-120lbs.

## Automotive Tools



## 1588

- ¼" water bib
- Easily fill radiators



## 43

- Filter wrench
- For removing standard 3 ½" to 3 ⅝" spin on filters
- 1 ¼" wide plated band with 7" vinyl grip

**43SP & 45SP**  
comes in retail skin pack packaging



## 45

- Chain type filter wrench
- For removing standard 4 ½" spin on filters
- 1 ¼" wide plated band with 7" vinyl grip

# INDUSTRIAL CLEANING PRODUCTS



## Parts Washer & Waste Disposal

### Parts Washer



Support Shelf



Fusible Link



Flexible Spigot



Parts Tray



### PW020

- Use with **water based solvent**
- 20 gallon capacity
- Solvent capacity: 12 gallons
- Self latching fire cover with fusible link
- Chrome steel flexible spigot
- Built in drain
- Re-circulates 50 gallons per hour
- Dimensions:  
L- 31 7/8" W- 20 7/8" H- 35 3/8"

### Replacement Pumps

- Purchased during or after 2016  
(PW02020)

### Industrial Gloves



### 514

- Plastic coated industrial gloves
- Heavy-duty abrasion and chemical resistant; for handling oil, acids, caustic materials, and many solvents

### Oily Waste Cans



### Features For Both (306) & (310):

- Foot operated cover
- Automatically closes when not in use
- Hold soiled rags and solvent cloths
- FM and UL listed
- Red high-density polyethylene

### 306

- 6 gallon capacity

### 310

- 10 gallon capacity

# INDUSTRIAL CLEANING PRODUCTS

## Disposable Cleaning Towels & Cleaners

### Disposable Cleaning Towels



#### Dyna-Wipes

- 9" x 12" dual sided cleaning towels

#### Use On:

- Your Hands
- Metal Tools & Equipment
- Stainless Steel
- Vinyl
- Glass
- Leather
- Tennis Shoes
- Clothing & Fabrics

#### Remove:

- Coffee Stains
- Carpet Spots
- Gasket Cement
- Plumber's cement
- Paints & Varnishes
- Permanent Marker
- Crayon Marks
- Tar & Asphalt
- Scuff Marks
- Pipe Cement
- Labels & Adhesive Residue
- Urethane Sealants



Model	# of Towels	Textured	Used For
796	80	Yes	Cleaning
796-120	120	No	Cleaning
796-25	30	No	Cleaning

### Highly Concentrated Cleaner

#### Features For Both (796-PMG) & (796-PMQ)

- Biodegradable
- Non-toxic
- Mix with water; 60:1

#### 796-PMG

- 1 gallon

#### 796-PMQ

- 1 quart



# CHEMICAL RESISTANCE

CHEMICAL NAME	ACCESSORIES							CHEMICAL PUMPS													
	MEASURES			FUNNELS				BATTERY POWERED		SIPHON			LEVER								
	753	755	757	759	761	764	798	7000	7019	369AR	10010	10020	373	374	375	376	377	10190	10191G	10193	
ACTALDEHYDE																					
ACETIC ACID: > 20%																					
ACETIC ANHYDRIDE																					
ACETONE																					
ALCOHOL: AMYL																					
ALCOHOL: BENZYL																					
ALCOHOL: BUTYL																					
ALCOHOL: DIACETONE																					
ALCOHOL: ETHYL																					
ALCOHOL: HEXYL																					
ALCOHOL: ISOBUTYL																					
ALCOHOL: ISOPROPYL																					
ALCOHOL: METHYL																					
ALCOHOL: PROPYL																					
AMMONIA: > 10%																					
AMMONIA, ANHYDROUS																					
AMMONIA, LIQUID																					
AMMONIUM HYDROXIDE																					
ANTI-FREEZE																					
BENZENE																					
BENZOIC ACID																					
BLEACH																					
BORIC ACID																					
CALCIUM CHLORIDE (30% IN WATER)																					
CALCIUM HYPOCHLORITE																					
CALCIUM SULFATE																					
CITRIC ACID																					
COPPER CHLORIDE																					
COPPER SULFATE: > 5%																					
DETERGENTS																					
DIESEL FUEL																					
ETHYL ACETATE																					
ETHYLENE GLYCOL																					
FORMIC ACID																					
FUEL OILS																					
GASOLINE (NOT UL LISTED)																					
GLYCERIN																					
HEPTANE (BRAKE CLEANER)																					
HYDROCHLORIC ACID: > 37%																					
HYDROCHLORIC ACID: > 50%																					
HYDROGEN PEROXIDE: > 30%																					
JET FUEL (JP3: JP4: JP5)																					
KEROSENE																					
LACQUERS																					
LACQUER THINNERS																					
LACTIC ACID																					
METHYL ETHYL KETONE (MEK)																					
MINERAL SPIRITS																					
NAPHTHA																					
NITRIC ACID: > 20%																					
OXALIC ACID (COLD)																					
PHOSPHORIC ACID: > 40%																					
PHOTOGRAPHIC (DEVELOPER)																					
POTASSIUM CHLORIDE																					
POTASSIUM HYDROXIDE																					
PROPYLENE GLYCOL																					
SILICONE																					
SODIUM BICARBONATE																					
SODIUM CHLORIDE																					
SODIUM HYDROXIDE: > 50%																					
SODIUM HYPOCHLORITE: < 20%																					
SODIUM NITRATE																					
SODIUM SULFATE																					
STODDARD SOLVENT																					
SULFURIC ACID: > 75%																					
TOLUENE, TOLUOL																					
TRICHLORETHANE																					
TRICHLORETHYLENE																					
TURPENTINE																					
UREA/DEF																					
XYLENE																					

Only pumps used for chemicals listed with a rating of "Excellent" will be covered under warranty.

**!WARNING!** This chart is intended as a guide to aid in the pump selection process. The information it contains has been gathered from reputable sources. However, National Spence Inc. assumes no responsibility for the accuracy or completeness of this information as it pertains to specific applications. If you need help selecting a pump, please call 800-231-1525.

**RATINGS-CHEMICAL EFFECT**

- No Effect-Excellent
- Minor to Moderate Effect-Fair
- Severe Effect-NOT Recommended

## CHEMICAL PUMPS

CHEMICAL NAME	LIFT										ROTARY										
	360	363	365	366T	387	10044	10050	10080	10110	10120	10130	1014	1014R	10210	10211	10231	10240	10250	10255	10256	11219
ACTALDEHYDE																					
ACETIC ACID: > 20%																					
ACETIC ANHYDRIDE																					
ACETONE																					
ALCOHOL: AMYL																					
ALCOHOL: BENZYL																					
ALCOHOL: BUTYL																					
ALCOHOL: DIACETONE																					
ALCOHOL: ETHYL																					
ALCOHOL: HEXYL																					
ALCOHOL: ISOBUTYL																					
ALCOHOL: ISOPROPYL																					
ALCOHOL: METHYL																					
ALCOHOL: PROPYL																					
AMMONIA: > 10%																					
AMMONIA, ANHYDROUS																					
AMMONIA, LIQUID																					
AMMONIUM HYDROXIDE																					
ANTI-FREEZE																					
BENZENE																					
BENZOIC ACID																					
BLEACH																					
BORIC ACID																					
CALCIUM CHLORIDE (30% IN WATER)																					
CALCIUM HYPOCHLORITE																					
CALCIUM SULFATE																					
CITRIC ACID																					
COPPER CHLORIDE																					
COPPER SULFATE: > 5%																					
DETERGENTS																					
DIESEL FUEL																					
ETHYL ACETATE																					
ETHYLENE GLYCOL																					
FORMIC ACID																					
FUEL OILS																					
GASOLINE (NOT UL LISTED)																					
GLYCERIN																					
HEPTANE (BRAKE CLEANER)																					
HYDROCHLORIC ACID: > 37%																					
HYDROCHLORIC ACID: > 50%																					
HYDROGEN PEROXIDE: > 30%																					
JET FUEL (JP3: JP4: JP5)																					
KEROSENE																					
LACQUERS																					
LACQUER THINNERS																					
LACTIC ACID																					
METHYL ETHYL KETONE (MEK)																					
MINERAL SPIRITS																					
NAPHTHA																					
NITRIC ACID: > 20%																					
OXALIC ACID (COLD)																					
PHOSPHORIC ACID: > 40%																					
PHOTOGRAPHIC (DEVELOPER)																					
POTASSIUM CHLORIDE																					
POTASSIUM HYDROXIDE																					
PROPYLENE GLYCOL																					
SILICONE																					
SODIUM BICARBONATE																					
SODIUM CHLORIDE																					
SODIUM HYDROXIDE: > 50%																					
SODIUM HYPOCHLORITE: < 20%																					
SODIUM NITRATE																					
SODIUM SULFATE																					
STODDARD SOLVENT																					
SULFURIC ACID: > 75%																					
TOLUENE, TOLUOL																					
TRICHLORETHANE																					
TRICHLORETHYLENE																					
TURPENTINE																					
UREA/DEF																					
XYLENE																					

**WARNING!** This chart is intended as a guide to help in the pump selection process. The information it contains has been gathered from reputable sources. However, National Spence Inc. assumes no responsibility for the accuracy or completeness of this information. It remains to specific applications. If you need help selecting a pump, please call 800-231-1525.

Only pumps used for chemicals listed with a rating of "Excellent" will be covered under warranty.

**Oil  
Equipment 4-39**

**Grease  
Equipment 40-61**

**Fuel  
Equipment 62-69**

**DEF  
Equipment 70-75**

**Chemical  
Equipment 76-89**

**Value Pumps 82-83**

**Accessories 84-101**

**Chemical  
Resistance  
Chart 102-103**

**Maximum  
Response  
Team 104**

**Top 12  
Best Sellers  
Inside Front Cover**

**New Products  
Inside Back Cover**

075BAV . . . . .	69	31SP . . . . .	59	82SS. . . . .	91
075NDT . . . . .	75	32 . . . . .	59	86 . . . . .	95
08DEF750 . . . . .	85	32SP. . . . .	59	88 . . . . .	85
1BAV. . . . .	69	33 . . . . .	57	89 . . . . .	87
10. . . . .	59	36 . . . . .	85	91. . . . .	.11
10SP. . . . .	59	36R . . . . .	56	92 . . . . .	.11
11SP . . . . .	56	36R-SP . . . . .	56	93 . . . . .	96
12R. . . . .	56	43 . . . . .	99	94 . . . . .	96
12R-1. . . . .	56	43SP. . . . .	99	95 . . . . .	96
12R-SP . . . . .	56	44 . . . . .	58	96 . . . . .	17
13R. . . . .	56	45 . . . . .	99	97 . . . . .	96
15-30 . . . . .	32	45SP. . . . .	99	98 . . . . .	17
17. . . . .	45	47SP. . . . .	58	100. . . . .	58
18R. . . . .	56	48 . . . . .	58	101. . . . .	29
18R-1. . . . .	56	48SP. . . . .	58	102. . . . .	58
18R-SP . . . . .	56	50R . . . . .	60	103. . . . .	64
18RR. . . . .	56	50SP. . . . .	60	104SM. . . . .	58
19R. . . . .	56	50Y . . . . .	60	105. . . . .	89
19R-SP . . . . .	56	52 . . . . .	58	105-S . . . . .	89
20 . . . . .	68	52SP. . . . .	58	108-5110. . . . .	19
20WB . . . . .	68	55 . . . . .	59	120 . . . . .	89
22 . . . . .	59	55SP. . . . .	59	120-S . . . . .	89
22SP. . . . .	59	57 . . . . .	91	130-S . . . . .	89
23 . . . . .	59	63 . . . . .	91	135. . . . .	89
23SP. . . . .	59	64 . . . . .	91	135WC. . . . .	89
24 . . . . .	59	65 . . . . .	59	137 . . . . .	89
25 . . . . .	58	65SP. . . . .	59	138-S . . . . .	89
25SP. . . . .	58	66 . . . . .	60	140-S . . . . .	89
26 . . . . .	26	66M . . . . .	60	140-SOR . . . . .	89
26A . . . . .	26	66SS. . . . .	60	145. . . . .	88
27 . . . . .	58	67 . . . . .	91	147. . . . .	88
27SP. . . . .	58	67SG. . . . .	91	148. . . . .	73, 88
28 . . . . .	58	68 . . . . .	91	149SP . . . . .	57
28SP. . . . .	58	68SP. . . . .	91	150. . . . .	88
29 . . . . .	59	80 . . . . .	59	151 . . . . .	74, 90
30A1. . . . .	64	80SP. . . . .	59	155. . . . .	32
31. . . . .	59	81. . . . .	91	159. . . . .	57



## Part # ..... Pg. #

167 . . . . .	90	376 . . . . .	80	707 . . . . .	95	785 . . . . .	95
169 . . . . .	67, 90	377 . . . . .	80	721 . . . . .	95	786 . . . . .	25
170 . . . . .	30, 80	381 . . . . .	30	723G . . . . .	95	790 . . . . .	94
173 . . . . .	51	382 . . . . .	30	731 . . . . .	96	791 . . . . .	94
175 . . . . .	68	386 . . . . .	78	732 . . . . .	96	796 . . . . .	101
186 . . . . .	57	387 . . . . .	74, 78	737 . . . . .	96	796-PMG . . . . .	101
202 . . . . .	64	410 . . . . .	54	743 . . . . .	96	796-PMQ . . . . .	101
227 . . . . .	35	413 . . . . .	54	745 . . . . .	96	796-25 . . . . .	101
234 . . . . .	35	414 . . . . .	54	748 . . . . .	96	796-25P . . . . .	101
236G . . . . .	35	415 . . . . .	54	751 . . . . .	96	796-120 . . . . .	101
237 . . . . .	35	419 . . . . .	54	752G . . . . .	96	798 . . . . .	94
240 . . . . .	82	420 . . . . .	54	753 . . . . .	96	799 . . . . .	94
306 . . . . .	100	444 . . . . .	54	754G . . . . .	96	830 . . . . .	90
309 . . . . .	36	514 . . . . .	100	755 . . . . .	96	911 . . . . .	51
310 . . . . .	100	540 . . . . .	47	757 . . . . .	96	912-19 . . . . .	50
312 . . . . .	36	541 . . . . .	47	757AR . . . . .	96	912-19L . . . . .	50
316 . . . . .	36	550 . . . . .	47	758G . . . . .	96	912-19LK . . . . .	50
318 . . . . .	36	567 . . . . .	47	759 . . . . .	94	912-20 . . . . .	50
321 . . . . .	29	609 . . . . .	53	760 . . . . .	96	913 . . . . .	97
327 . . . . .	49	610 . . . . .	52	760AR . . . . .	96	914 . . . . .	51
328 . . . . .	49	613 . . . . .	52	761 . . . . .	94	915 . . . . .	51
331 . . . . .	48	615 . . . . .	53	761AR . . . . .	96	916 . . . . .	97
333 . . . . .	48	619 . . . . .	52	764 . . . . .	94	918 . . . . .	97
336 . . . . .	32	620 . . . . .	52	765 . . . . .	95	924 . . . . .	62
338 . . . . .	32	620CTB . . . . .	55	766 . . . . .	95	925 . . . . .	62
343 . . . . .	48	620CTG . . . . .	55	769 . . . . .	94	926 . . . . .	63
353 . . . . .	29	620CTK . . . . .	55	770 . . . . .	94	927 . . . . .	63
360 . . . . .	81	620CTP . . . . .	55	772 . . . . .	94	930 . . . . .	62
363 . . . . .	81	620CTR . . . . .	55	774 . . . . .	94	936G . . . . .	28
365 . . . . .	74, 81	620CTS . . . . .	55	775 . . . . .	94	938G . . . . .	28
366 . . . . .	34	620CTY . . . . .	55	776 . . . . .	94	942 . . . . .	63
366T . . . . .	34	625 . . . . .	48	778 . . . . .	94	945 . . . . .	62
369 . . . . .	81	660 . . . . .	57	780 . . . . .	96	960 . . . . .	66
369AR . . . . .	81	699J . . . . .	94	782 . . . . .	92	961 . . . . .	66
373 . . . . .	74, 80	701 . . . . .	95	783 . . . . .	92	962 . . . . .	66
374 . . . . .	80	703 . . . . .	95	784 . . . . .	92	963 . . . . .	66
375 . . . . .	74, 80	705 . . . . .	95	784L . . . . .	92	975 . . . . .	31

## Part # . . . . . Pg. #

1000R . . . . .	96	1213A-50 . . . . .	43	1477NS . . . . .	97	1525G . . . . .	25
1002 . . . . .	67	1213R . . . . .	42	1481NS . . . . .	86	1527 . . . . .	12
1003 . . . . .	67	1213R-00 . . . . .	42	1482NS . . . . .	86	1529 . . . . .	12
1006 . . . . .	65	1213R-10. . . . .	42	1496NS . . . . .	87	1531 . . . . .	23
1006H . . . . .	65	1213R-12. . . . .	42	1497NS . . . . .	87	1533 . . . . .	45
1006HFM . . . . .	65	1213R-16. . . . .	42	1500 . . . . .	23	1534 . . . . .	45
1009 . . . . .	78	1213R-25 . . . . .	42	1502 . . . . .	23	1536A . . . . .	45
1009H . . . . .	78	1213R-50 . . . . .	42	1503 . . . . .	25	1537 . . . . .	69
1014 . . . . .	79	1214A . . . . .	42	1504 . . . . .	5, 22	1537-10 . . . . .	69
1014R . . . . .	79	1220R . . . . .	42	1504AR . . . . .	13	1537C . . . . .	69
1025 . . . . .	77	1220R-12 . . . . .	42	1505 . . . . .	23	1537C-10 . . . . .	69
1035 . . . . .	16	1220R-16 . . . . .	42	1507 . . . . .	22	1537WS . . . . .	69
1035K . . . . .	17	1230 . . . . .	38	1508 . . . . .	24	1538 . . . . .	69
1035K2 . . . . .	17	1231 . . . . .	38	1508G . . . . .	24	1538-10 . . . . .	69
1035SP . . . . .	71	1234 . . . . .	36	1508GG . . . . .	24	1538C . . . . .	69
1037 . . . . .	16	1235 . . . . .	37	1508L . . . . .	24	1538C-10 . . . . .	69
1038 . . . . .	16	1236 . . . . .	37	1508Q . . . . .	24	1538WS . . . . .	69
1040 . . . . .	16	1315 . . . . .	26	1509 . . . . .	22	1539 . . . . .	69
1040K . . . . .	17	1315A . . . . .	26	1512 . . . . .	63	1539-10 . . . . .	69
1040SS . . . . .	16	1326 . . . . .	26	1514 . . . . .	63	1539C . . . . .	69
1040UL . . . . .	16	1330 . . . . .	26	1514L. . . . .	63	1539C-10 . . . . .	69
1041 . . . . .	18	1335 . . . . .	26	1515 . . . . .	24	1541 . . . . .	69
1043 . . . . .	18	1340 . . . . .	26	1515A . . . . .	24	1542 . . . . .	69
1044 . . . . .	18	1440R . . . . .	86	1515G . . . . .	24	1543 . . . . .	69
1101. . . . .	21	1440HD . . . . .	86	1515GG . . . . .	24	1544 . . . . .	45
1183 . . . . .	98	1444R . . . . .	5, 86	1515L. . . . .	24	1545 . . . . .	45
1208 . . . . .	33	1444HD . . . . .	86	1517 . . . . .	20	1547 . . . . .	45
1209 . . . . .	33	1448R . . . . .	86	1518 . . . . .	99	1550 . . . . .	98
1209RAR . . . . .	33	1456R . . . . .	86	1519 . . . . .	21	1554 . . . . .	98
1212A . . . . .	44	1458NS . . . . .	87	1519L. . . . .	21	1556BV . . . . .	98
1212R . . . . .	44	1458R . . . . .	86	1520 . . . . .	5, 21	1558A . . . . .	98
1213A . . . . .	43	1459NS . . . . .	87	1520GG . . . . .	21	1559A . . . . .	98
1213A-00 . . . . .	43	1474R . . . . .	86	1520L . . . . .	21	1559A-ASSY . . . . .	98
1213A-10. . . . .	43	1475R . . . . .	5, 82	1522 . . . . .	20	1559A2-ASSY . . . . .	98
1213A-12. . . . .	43	1470NS . . . . .	97	1523 . . . . .	46	1561 . . . . .	98
1213A-16. . . . .	43	1472NS . . . . .	97	1524 . . . . .	46	1561G . . . . .	98
1213A-25 . . . . .	43	1476NS . . . . .	97	1525AR . . . . .	25	1562 . . . . .	99

## Part # ..... Pg. #

1563 . . . . .	99	1737 . . . . .	10	5072 . . . . .	75	9115TK. . . . .	72
1564 . . . . .	99	1745 . . . . .	15	5265 . . . . .	28	9115TKSN. . . . .	72
1565 . . . . .	98	1785 . . . . .	19	5702 . . . . .	75	9115TKSNM . . . . .	72
1565L . . . . .	98	1795 . . . . .	77	5703 . . . . .	75	9116 . . . . .	72
1567 . . . . .	99	1802 . . . . .	85	5792 . . . . .	74	9810 . . . . .	17
1570 . . . . .	98	1804 . . . . .	85	6104 . . . . .	5	9825 . . . . .	17
1570L . . . . .	98	1806 . . . . .	85	6105 . . . . .	5	10010 . . . . .	81
1572G . . . . .	26	1810 . . . . .	85	6112 . . . . .	5	10020 . . . . .	81
1572GAR . . . . .	26	1812 . . . . .	85	6116 . . . . .	5	10039-1P . . . . .	85
1572GSW . . . . .	26	1816 . . . . .	85	6120 . . . . .	5	10044 . . . . .	81
1573A . . . . .	98	1820 . . . . .	85	6124 . . . . .	5	10050 . . . . .	81
1574 . . . . .	98	1825 . . . . .	85	6204 . . . . .	5	10066 . . . . .	60
1575G . . . . .	26	1850 . . . . .	85	6215 . . . . .	39	10066M . . . . .	60
1578 . . . . .	98	2134 . . . . .	85	6401 . . . . .	5	10080 . . . . .	83
1580G . . . . .	26	2136 . . . . .	85	6403 . . . . .	5	10110 . . . . .	78
1588 . . . . .	99	2154 . . . . .	85	6404 . . . . .	5	10120 . . . . .	83
1590 . . . . .	23	2156 . . . . .	85	6405 . . . . .	5	10130 . . . . .	83
1590AR . . . . .	23	2158 . . . . .	85	6520 . . . . .	5	10190 . . . . .	83
1608R . . . . .	12	2178 . . . . .	85	6601 . . . . .	27	10191G. . . . .	83
1608RNL . . . . .	12	3024 . . . . .	28	6611 . . . . .	5, 27	10193. . . . .	74, 78
1610R . . . . .	13	3574A . . . . .	41	6612 . . . . .	5, 27	10210. . . . .	83
1615R . . . . .	13	3574A-10 . . . . .	41	6613 . . . . .	5, 27	10211. . . . .	74, 79
1620R . . . . .	13	3574A-12 . . . . .	41	6614 . . . . .	5, 27	10231. . . . .	79
1625R . . . . .	13	3574A-16 . . . . .	41	7000 . . . . .	76	10231TK. . . . .	72
1630R . . . . .	13	3574A-20 . . . . .	41	7002 . . . . .	76	10240 . . . . .	79
1635R . . . . .	13	3574A-25 . . . . .	41	7019 . . . . .	70	10250 . . . . .	78
1700R . . . . .	14	3574R . . . . .	40	7019L . . . . .	70	10255 . . . . .	79
1702R . . . . .	15	3574R-00 . . . . .	40	7019ACK . . . . .	70	10256 . . . . .	79
1712 . . . . .	5	3574R-10 . . . . .	40	7020 . . . . .	70	10265 . . . . .	90
1712PPV. . . . .	12	3574R-12 . . . . .	40	7050 . . . . .	4	10266 . . . . .	90
1713 . . . . .	11	3574R-16 . . . . .	40	7051 . . . . .	4	10267 . . . . .	90
1714 . . . . .	11	3574R-20 . . . . .	40	9008 . . . . .	73, 83	11219 . . . . .	74, 78
1716 . . . . .	11	3574R-25 . . . . .	40	9112 . . . . .	72	11219MM . . . . .	74
1722 . . . . .	12	3713 . . . . .	91	9115 . . . . .	72	15216. . . . .	27
1730A . . . . .	6	5001 . . . . .	91	9115DSS. . . . .	73	15219. . . . .	14
1730R . . . . .	14	5002 . . . . .	91	9115SS. . . . .	68	15221. . . . .	14
1735R . . . . .	14	5003 . . . . .	91	9115TKBS. . . . .	68	15222 . . . . .	14

15441 . . . . .	69	DB-100T . . . . .	75	L30-99N . . . . .	30, 64
18573 . . . . .	46	DEF-005 . . . . .	71	LO100 . . . . .	84
28623 . . . . .	10	DEF-005EC . . . . .	71	NS-CTB . . . . .	55
28625 . . . . .	15	DEF-010 . . . . .	71	NS-CTG . . . . .	55
47721 . . . . .	60	DEF-010EC . . . . .	71	NS-CTK . . . . .	55
47722 . . . . .	60	DEF-020 . . . . .	71	NS-CTP . . . . .	55
47724 . . . . .	60	DEF-020EC . . . . .	71	NS-CTR . . . . .	55
47725 . . . . .	60	DEF-027 . . . . .	71	NS-CTS . . . . .	55
66590 . . . . .	46	DEF-027EC . . . . .	71	NS-CTY . . . . .	55
75000 . . . . .	69	DEF-028 . . . . .	71	NS-10 . . . . .	68
75100 . . . . .	69	DEF-028EC . . . . .	71	NS-10W . . . . .	68
91201-19 . . . . .	50	DEF-15 . . . . .	71	NS-10-BSP . . . . .	68
91201-19L . . . . .	50	DEF55-A . . . . .	73	NS-30 . . . . .	68
91202-19 . . . . .	50	DEF55-BK . . . . .	73	NS-30AR . . . . .	68
91202-19L . . . . .	50	DEF-504G . . . . .	71	NS-40 . . . . .	68
91203-19 . . . . .	50	DEF-601 . . . . .	75	NS-40WB . . . . .	68
103501 . . . . .	17	DEF-905 . . . . .	71	PW020 . . . . .	100
104001 . . . . .	17	DEF-906 . . . . .	71	TG60 . . . . .	84
104006G . . . . .	30	DEF-7925 . . . . .	71, 87	TG72 . . . . .	84
107012 . . . . .	48	DEF-107233 . . . . .	71	URM100 . . . . .	90
107016 . . . . .	46	DEF-V750 . . . . .	85	Z-131 . . . . .	93
A-101 . . . . .	93	DG-55 . . . . .	84	Z-132 . . . . .	93
A-102 . . . . .	93	EFP-005 . . . . .	82	Z-133 . . . . .	93
A-103 . . . . .	93	FCRS-100 . . . . .	4	Z-134 . . . . .	93
A-104 . . . . .	93	Grease Fittings . . . . .	61		
BK-100 . . . . .	99	GS541 . . . . .	47		
BK-100-B . . . . .	99	HD4 . . . . .	55		
BOWL . . . . .	68	HD4A . . . . .	55		
D01 . . . . .	30	HD4ACTB . . . . .	55		
D-100 . . . . .	93	HD4ACTG . . . . .	55		
D-101 . . . . .	93	HD4ACTK . . . . .	55		
D-102 . . . . .	93	HD4ACTP . . . . .	55		
D-108 . . . . .	93	HD4ACTR . . . . .	55		
D-S . . . . .	30	HD4ACTS . . . . .	55		
D-S1 . . . . .	30	HD4ACTY . . . . .	55		
DB-100 . . . . .	75	L30-94N . . . . .	64		
DB-100AR . . . . .	75	L30-95N . . . . .	85		



## The Maximum Response Team

*We promise to provide the best service in our industries.*

*You will always receive our Maximum Response.*

**Rick England**



President/CEO

**Russell Spurgeon**



Vice President

**Kelly Eisenman**



V.P. - Finance

**Kirk Lies**



National Sales Manager

**Anne Hansen**



Plant Manager

**Sadie Horrell**



Accounts Payable

**Kim Chambers**



Accounts Receivable

**Wendy Brixley**



Receptionist

**Travis Howell**



Customer Service

**Nick Elsen**



Customer Service

**Baye Winegar**



Marketing / Rep Contact

*Introducing the  
members of the  
Maximum  
Response Team*

## CORDLESS GREASE GUN

### 912-20



**Includes:**

- Shoulder strap
- Hard plastic carrying case
- (1) AC charger
- (2) 20 volt Lithium ion batteries
- mAh: 2,000
- 2-year limited warranty

**Features:**

- Max Pressure: 10,000 PSI
- Dispenses approximately (8) 14oz tubes per charge
- 42" whip hose with spring guard
- Large digital display
  - A. Battery level indicator
  - B. Grease indicator shows amount of grease remaining
  - C. Amount of grease dispensed per each activation
  - D. Display flashes when no grease is being dispensed
  - E. 180° viewing angle
- 1 watt LED work light
- High and low volume settings
- Motor has thermal overload protection
- Built-in floor stand



## DUAL MODE AIR OPERATED GREASE GUN

**Dual Mode:**

- Fully automatic free outflow and single shot / grease discharge on demand

- Switch between fully automatic-continuous grease flow operation and on-demand/single shot operation, with the slide of an easy to use button

- Complete with 30" (760 mm) flexible grease hose & coupler



### 915



Press button for Single Shot Operation



Slide backwards for Continuous Mode

Specifications	
Develops	Up to 6,000 PSI
Delivers One Shot Mode	Up to 0.90 gm / shot (1.30 oz / 40 strokes)
Delivers Continuous Flow	Up to 400 gm / min (14 oz / min)
Air Operating Range	40-150 PSI (30-10 BAR)
Pressure Ratio	40:1
Air Compressor Volume	1 cfm / 0.026 cbm
Air Inlet Threads	1/4" (F)

## ELECTRIC DEF TRANSFER PUMP

**Rugged Construction**

- Stainless Steel SS 304 imparts durability and extended life to the pump as compared to commonly available regular polypropylene/ nylon pumps.

**Vane Pump Mechanism**

- The centrifugal vane pumping mechanism makes it more effective with enhanced suction lift & self priming feature as opposed to regular pumps that require priming and have limited suction ability.

**Continuous Duty**

- Time Saving Pump. Can run continuously without any stoppage, as opposed to regular pumps with a duty cycle of 15-20 minutes. 15 GPM flow rate.

**Safe Operation**

- Pump constructed using totally enclosed motor.

Specifications	
Description	115V AC
Pump type	Vane
Motor	1/2 hp, 60hz
RMP	3400
Amp	3
Dry suction height	1m (32")
Inlet/Outlet	1"
Power cable	1.6m (5-1/2")
Duty cycle	Continuous
Water/Dust protection	IP54



### 9116

## MEASURING FUNNEL



### 779



**Features:**

- Funnel comes with graduation marks
- Measures in US quarts and liters
- Funnel capacity is 2 quarts
- Heavy duty polyethylene construction
- Lid and base for spill free and safe storage
- Built in metal sieve for contaminant free transfer
- Convenient and hassle free



**NATIONAL - SPENCER, INC.**

## **SALES & SERVICE**

**TEL: 800-231-1525 | E-MAIL: SALES@ZEELINE.COM | FAX: 800-637-9511**

## **CORPORATE & SALES OFFICE**

**National - Spencer, Inc  
P.O. Box 57  
Wichita, KS 67201**



### **FACTORY & WAREHOUSE**

**National - Spencer, Inc  
1209 32<sup>nd</sup> Ave. West  
Spencer, IA 51301**

### **WAREHOUSE**

**National - Spencer, Inc  
2334 Stagecoach Road, Suite G  
Stockton, CA 95215**

**[www.ZEELINE.com](http://www.ZEELINE.com)**